

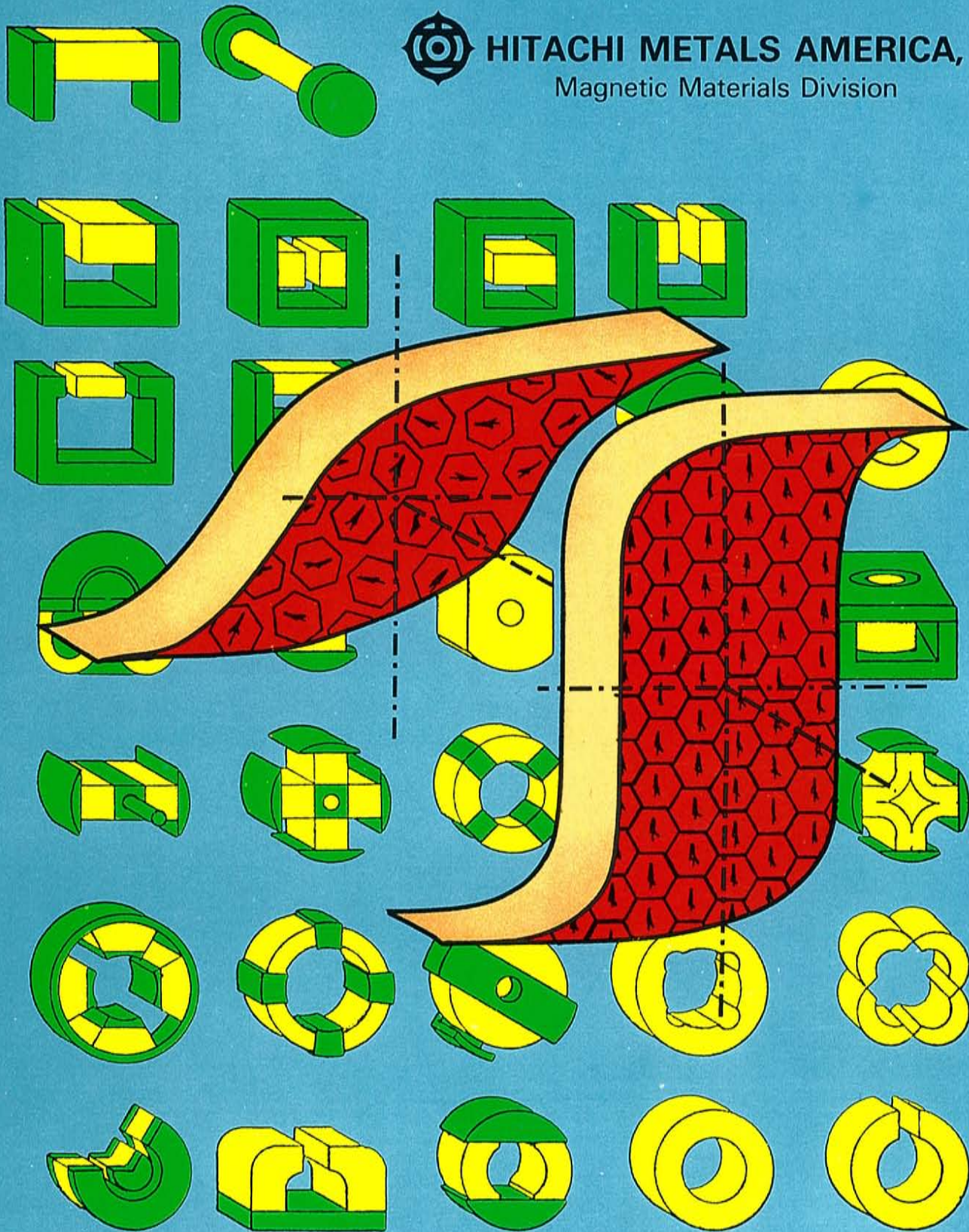

HITACHI METALS AMERICA, LTD.

Magnetic Materials Division



HITACHI METALS AMERICA, LTD.

Magnetic Materials Division

7800 NEFF ROAD • EDMORE, MICHIGAN 48829 U.S.A.
PHONE (517) 427-5151 • FAX (517) 427-5772 or (517) 427-5571

CONTENTS

Theory of Magnetization.....	2
Characteristics of Magnetic Materials	6
Permanent Magnet Materials	10
Energy and Permanent Magnets	14
Magnet Design.....	16
Magnet Stability	24
Permanent Magnet Measurements	27
Magnetization and Demagnetization.....	28
Glossary of Magnet Terms.....	30
Symbols.....	34
Specifying the Permanent Magnet	36
Typical Magnetic and Physical Properties.....	37
Hitachi Magnets Demagnetization Curves	38 - 40



HITACHI METALS AMERICA, LTD.

Magnetic Materials Division

7800 NEFF ROAD • EDMORE, MICHIGAN 48829
PHONE (517) 427-5151 • FAX (517) 427-5772 or 427-5571

The Theory of Magnetism

For centuries, magnets were looked upon as magical devices or curios. Not until the closing years of the 19th century did they begin to find commercial applications.



Fig. 1. In the 1600's, William Gilbert discovered that a magnet could be made by heating an iron bar, then letting it cool in the direction of the earth's field.

Modern life as we know it would not be possible were it not for permanent magnets. If you think this is an exaggeration, consider the number of everyday devices that would cease to operate without permanent magnets: electric clocks would stop . . . your radio or TV would be useless . . . all electrical communication would fail . . . and the distribution of power would be impossible. It has been estimated that your home contains more than 50 permanent magnets, while commercial and military applications number in the thousands.

To be sure, magnets play only one part, and many other scientific discoveries were necessary to develop our present-day technology. However, the story of man's understanding of magnetism parallels his understanding of the other natural sciences.

The first permanent magnets known were discovered in Magnesia — thus the name "magnes" — several thousand years ago. Since these were used by early mariners as an aid in navigation, they were called lodestones, after the lodestar (or guiding star). It is known now that these magnets were a variety of magnetite, Fe_3O_4 , which is magnetic in the natural state. No attempt was made to explain the attractive force of the lodestone, but rather it was considered to possess supernatural powers.

Early studies by Gilbert and Oersted

The first great theoretical study of magnetism was conducted by William Gilbert and reported in 1600. For the first time, the magnet was viewed scientifically rather than as an object of magic or superstition.

Starting with lodestones, Gilbert developed methods of making magnets from iron, discovered the effect of pole pieces, and established that the world itself is a magnet. He found, for example, that red heat destroyed permanent magnetism, and, conversely, that a red-hot iron bar left to cool in the direction of the earth's field became permanently magnetic.

He could not go beyond this, as the science of electricity had not yet been developed. Consequently, permanent magnets remained an interesting but useless curio for the next few hundred years.

Oersted discovers the origin of magnetic fields

The origin of magnetic fields was discovered by Hans Christian Oersted in 1820. Before Oersted, many had assumed there was some interaction between electricity and the magnetic phenomena, but this fact had not been established. Oersted found

that when a compass was brought near a wire carrying a direct current, the compass needle pointed in a direction at right angles to the current. By moving the compass needle around the current-carrying wire, Oersted was able to explore the magnetic field, and showed it to be in the form of circles ringing the wire.

The first important relationship between electricity and magnetism was established: magnetic fields are produced by charges in motion or by an electrical current.

It followed logically that when a coil of wire was wound around a small cylinder and energized, it would produce an external magnetic field very much like that of a magnetized iron bar, with poles at either end. Again the trail ended here, as it was necessary to have an understanding of atomic physics (a subject unheard of at that time) to appreciate the similarity of permanent magnets and **electromagnets**.

Alloys increase magnetic strength

Understanding the causes of magnetism had to wait. However, magnets began to find commercial applications, and man began to find ways to make them stronger and more useful. Although these developments were achieved largely by trial and error, in some cases accidentally, they were impressive. Toward the end of the 19th century, it was found that alloy additions of tungsten or chromium would greatly increase the usefulness of permanent magnets. It was subsequently found that the addition of cobalt further improved the properties and usefulness of magnet steels. The magnetic properties of these steels were developed by heat treating in exactly the same manner they were hardened. In fact, it became common practice to refer to the magnetic properties in terms of the hardness of the alloy, thus the term “magnetically hard” and “magnetically soft.”

The most significant advance was the development of Alnico permanent magnets in the early 1930's. Permanent magnets finally achieved sufficient strength and stability to find widespread use in industry. To this day, Alnico magnets are the most widely used magnetic material, and it appears they will be for years to come.

Each atom is a small magnet

But let us go back to where Oersted left off and see if, in light of the knowledge gained in the last hundred years, we can now explain the inner workings of the permanent magnet. To do this, we must look into the structure of matter.

It is well known now that an atom can be regarded as a positively charged nucleus surrounded by electrons which not only move about the nucleus in definite orbits, but also spin on their own axes. It has been found that magnetism is associated almost entirely with this spinning motion of the electrons in the third shell of the atomic structure. Here, then, is the similarity between permanent magnets and

electromagnets. The spinning motion of the electrons is the same as the electrons moving through a coil of wire. The effect is the same as Faraday found: magnetic fields are produced by charges in motion or by an electric current.

In most materials there is an identical number of electrons spinning in one direction as in the other. Since the polarity of the magnetic field is determined by the direction of the electron spin, the equal numbers of opposite magnetic fields cancel each other out, and there is no magnetic field produced.

The peculiarity of a **ferromagnetic material** is that there are more electrons spinning in one direction than in the other. Each atom then is a small electromagnet. We now see the basic building block of all magnetism, namely the atomic magnet, which, because of the direction of electron spin, has a magnetic moment. We need only enlarge the picture of the atomic magnet to see how a ferromagnetic material produces **magnetic flux**.

The idealized picture is one where all the atoms are so arranged that the electrons spin in the same direction. In this case, all of the atomic magnetic moments will also be in the same direction and their magnetic forces will be combined. A magnetized piece then derives its magnetism from the coordinated circular spin of the electric charges in the third shell of the atom. We need only find how it is possible to align the elemental magnets and we will have the complete story.

Atoms are aligned by electrostatic force

Our discussion so far has neglected one important factor — the kinetic theory of matter. According to this well-established theory, atoms are constantly vibrating and rotating. The higher the temperature of the material, the higher will be the kinetic energy of the atoms; that is, they will be vibrating more vigorously. If each atom of our magnet were to act independently of its neighbor, the atoms would be vibrating and rotating with so much energy that it would require a fantastically large magnetizing force to align these particles. Such a force would have to be far greater than anything we can produce. Therefore, it is necessary that some internal force be present to restrict the independent action of the atoms.

Such a force does exist in some elements, and accounts for the difference between magnetic and non-magnetic materials. This electrostatic force, called exchange interaction, maintains neighboring groups of atoms parallel against the forces of thermal agitation. It can then be seen why a material becomes non-magnetic when it is heated above its Curie temperature. The additional heat provides enough atomic thermal agitation to overcome the constraining forces of exchange interaction, and it is no longer possible to maintain the atomic alignment.

The domain — a practical building block

It would be ideal if this exchange interaction would align all the atoms in a magnet; tremendously strong permanent magnets would result. Such is not the case. For some reason, not now understood, these forces are only effective over a limited volume (estimated at a million-billion atoms or 10^{-8} cubic centimeters). In these limited volumes, called domains, all the atomic moments are aligned, and the domain is magnetically saturated at all times.

The concept of a domain is the most significant factor in understanding magnetism, as it represents the practical building block of magnets.

A magnetic material is saturated magnetically at all times. In the unmagnetized condition, the domains are randomly oriented, and internal flux paths exist; no field exists outside the magnet.

Classification of materials

We now have a qualitative picture of how a magnet works, and we can group materials according to their magnetic properties — or their reaction to an applied magnetic field.

If a bar of a given material is suspended between the poles of a powerful magnet, it will either be aligned with the field or turn at right angles to the field. Those which are repelled by the field are called **diamagnetic**, while those which align are **paramagnetic**. The difference is attributable to their atomic structure. Paramagnetic materials are composed of atoms which have a magnetic moment even when no field is applied. The atoms of diamagnetic materials do not normally have a magnetic moment. When an external magnetic field is applied, there will be a slight field induced, but it will be of the same polarity, and the bar is repelled.

Ferromagnetic materials

Within the area of paramagnetic materials, there

is a special classification of materials called ferromagnetic because they show a far greater magnetizability. It can also be said that the reason they are ferromagnetic is that internal forces (exchange interaction) are present that hold groups of atoms parallel and form domains, as we have previously seen. This group of ferromagnetic materials is the one we are concerned with in our study of magnetism.

Magnetization changes internal energy

When a magnetizing field is applied, it is only necessary to control the orientation of the domains to control the potential energy of the magnet. More precisely, the external magnetizing field changes the balance of the much larger internal energies of the magnetic system. (This is similar, in a sense, to the case where a relatively small current controls large values of power in an electrical circuit.)

External work is required to orient the domains and magnetize the piece. It is important to recognize that a like amount of external work is required to demagnetize the piece. Once magnetized, a piece will stay that way until external energy is applied.

We have seen that the distinguishing feature of ferromagnetic materials is the presence of an internal force that holds groups of atoms parallel, forming domains. Where two domains come together, the change in direction of magnetization does not occur abruptly, but extends over hundreds of atomic planes forming "domain boundaries". This is shown schematically in Figure 2. Between the domains atomic magnets are progressively rotated, becoming less stable. It can be readily seen that these intermediate areas will be easily affected by an external field, since less energy is required to change their magnetization.

Magnetizing consists of: (1) stretching the domain boundaries, (2) growth of those domains

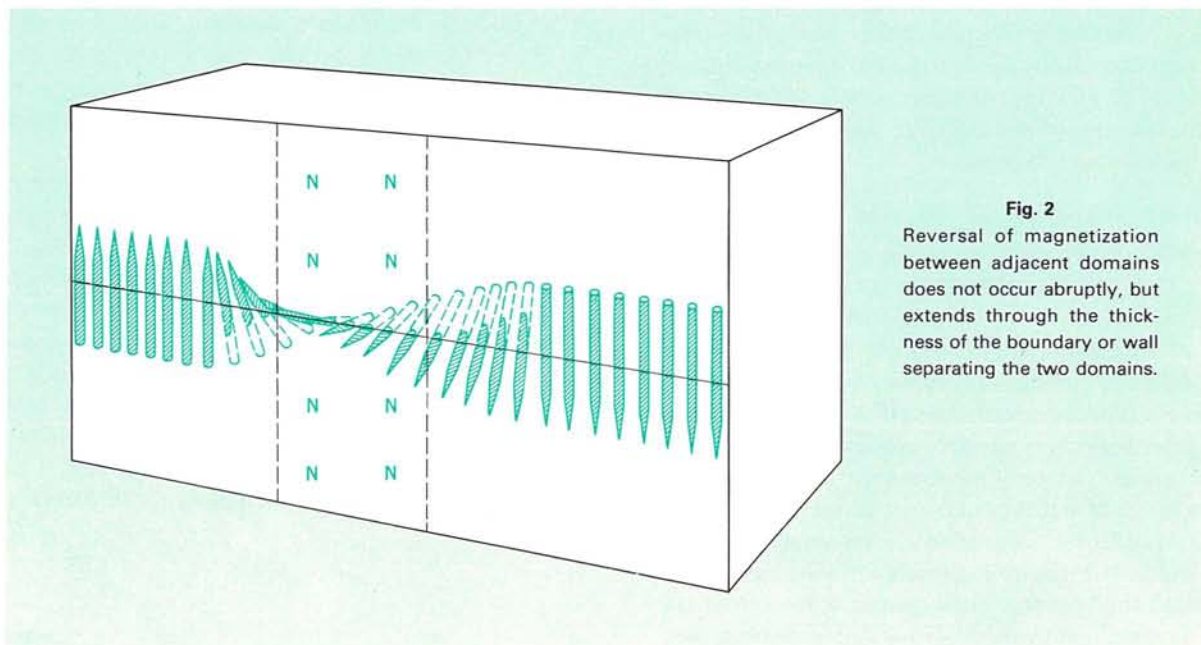

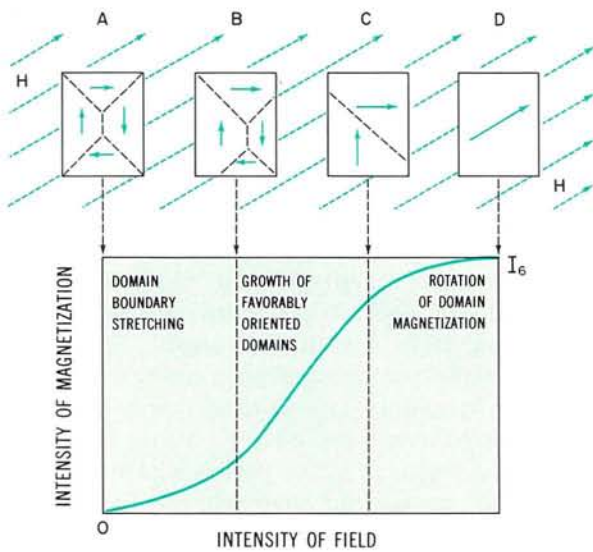

Fig. 3

oriented in the same direction as the applied field, (3) rotation of the domain against its normal direction of magnetization. This is shown in simplified form in Figure 3, with the corresponding effect of magnetization of the material plotted against magnetizing force.

At first, the effect is to stretch the domain boundaries, which causes only a slight magnetization of the piece. This initial magnetization is reversible; the domain boundaries will return to their original position if the field is removed. As the intensity is increased, the boundaries move and those domains more closely aligned with the field grow at the expense of the unfavorably aligned ones. This is accompanied by a sharp increase in irreversible magnetization. Finally, the domains are rotated, or forced, to align with the applied field. This creates only a slight increase in magnetization; when the field is removed, the domains will rotate back to their preferred direction. The boundaries of **soft magnetic materials** must be made easy to move in response to low fields, whereas the boundaries of permanent magnets must be made difficult to move so they will resist demagnetizing fields.

Fine particle theory

One obvious approach to impede domain-boundary motion is to introduce structural inhomogeneities into the material. Early permanent magnets, such as quench-hardened steels, derived their properties from non-magnetic inclusions which served this purpose.

A far more effective means to impede domain-boundary motion is to prepare particles smaller than the width of a normal domain boundary. Such particles will be too small to contain a boundary and will have to be a single domain. Magnetization can then take place only by the rotation of the magnetic moment, a much more difficult process than simple domain-boundary motion. The greater the forces which resist the rotation of the domain, the greater are the coercive forces of the material.

Anisotropic forces

These resisting forces are called anisotropic forces and can be accounted for by one of the following mechanisms:

- (1) crystal anisotropy, due to a preferred crystallographic plane of easy magnetization;
- (2) strain anisotropy, due to a preferred direction of magnetization with respect to physical strain;
- (3) shape anisotropy, due to a preferred direction of magnetization along the length of a single domain particle; and
- (4) exchange anisotropy, due to the coupling of the atomic spin system of two dissimilar materials.

All modern high **coercive force** materials such as the Alnicos, ferrites, and Hicorex derive their magnetic properties from fine, single-domain particles whose coercive force is developed by one or more of the above mechanisms. As particle size is reduced, a continuous increase in coercive force is observed. An understanding of the contributions of anisotropic forces and the effect of particle size is the basis for a new series of permanent magnet materials.

It has been found that Hicorex and ferrite develop a very high coercive force strictly from crystal anisotropy. The Alnico series develops coercive force primarily from the shape anisotropy of sub-microscopic particles precipitated during heat treatment. To be useful, magnets must have both high coercive force to resist demagnetization and a high flux-carrying capacity or induction.

The coercive force of Lodex results from the growth of shaped iron cobalt particles in an electrolytic cell. These particles are assembled and ordered to form a wide range of unit properties. The Lodex process actually synthesizes that which before was possible only in a high temperature metallurgical reaction.

There are still many gaps in our understanding of magnetism. As we learn more about the structure of matter, we learn more about magnetism and how to apply it to our needs. Just as rapid progress in both our understanding of the physics of magnetism and how to make stronger magnets has been made in recent years, so will rapid progress be made in the years ahead. This will be accomplished when we learn how to control the anisotropic forces responsible for developing coercive forces. We cannot say now just what form the magnets of the future will take. We do know they will play an even greater part in contributing to our comfort and security.

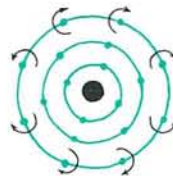

Characteristics of Magnetic Materials

Magnetic energy is not created. It is either stored in the permanent magnet or in the surrounding space. It cannot be used up or destroyed.

Like other fields of special study, magnetism has a language all its own, and a comprehensive discussion of magnets requires the use of expressions and words which are peculiar to this field. This is unfortunate, as the beginner in this subject is required not only to learn new concepts, but at the same time must learn a whole new vocabulary. To minimize this, it is often helpful to consider the analogy between electrical and magnetic circuits. The analogy is far from being complete. However, many magnetic circuit concepts are more easily understood by a consideration of the electrical equivalent.

Terminology of magnetic measurement

In an electrical circuit, an electromotive force (E) causes a current (I) to flow through a resistance (R). Likewise a magnetomotive force (mmf) establishes the flux (ϕ) in a circuit having a reluctance (\mathcal{R}).

The unit of magnetizing force is called a **gilbert** and the unit in the magnetic field is a **maxwell**, or one line of flux. Rather than to express these in absolute quantities, it is customary in magnetic work to express these terms on a unit basis. Thus, **magnetizing force** is measured in **oersteds**, or gilberts per centimeter. Magnetic field intensity is measured in **gauss**, or maxwells per square centimeter. It is more common to work with the reciprocal of reluctance or **permeance**. (Permeance is a function of magnet design and will be discussed in detail later.) With these basic terms and only a few more, it is possible to describe the important characteristics of magnetic materials.

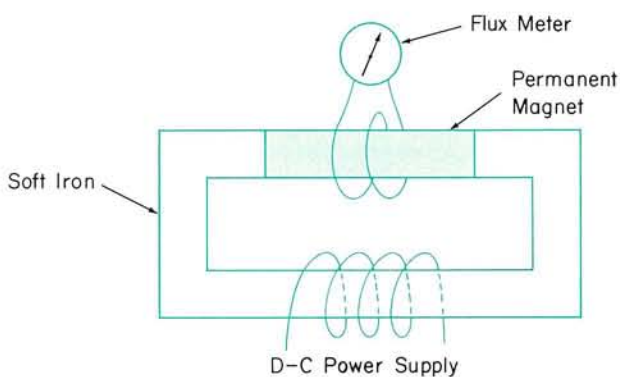

Fig. 4. Magnetizing force is applied to magnetic material by an electromagnet, while flux is measured by a flux meter.

Assume that a piece of magnetic material which has not been magnetized is placed between the poles of an electromagnet (Figure 4) and the current in the magnetizer is gradually increased. This subjects the magnet to a gradually increasing magnetizing force H (oersteds), which is proportional to the increasing current. If at the same time the resultant induction, B (gauss), of the permanent magnet is measured and plotted against the magnetizing force, the dotted curve from O to X shown in Figure 5 is developed.

Point X represents the point at which the magnet is saturated, or $+B_{max}$. Additional magnetizing force will not increase magnetization once a piece is saturated.

If the magnetizing force, H , is gradually reduced from the highest applied value, $+H_{max}$ to zero, the resultant induction in the material decreases to a value B_r , known as the **residual induction**. If the magnetizing force is then reversed (by reversing the current in the coil of wire) and increased in the negative direction, the resultant induction in the material is reduced to zero. At this point, the value of the demagnetizing force is $-H_c$, known as the **coercive force**. Increasing the demagnetization force to $-H_{max}$ results in changing the value of B from positive to negative or changing the polarity of the material. The balance of the curve is obtained by repeating the process but starting with $-H_{max}$. Thus, we obtain the normal **hysteresis loop** for the magnetic material.

This type of curve applies to all magnetic materials. Materials which have a low coercive force are low energy or soft magnetic materials. High coercive force materials are high energy materials or permanent magnets.

Soft magnetic materials are used in applications where they are alternately magnetized and demagnetized by an external force. The most common use of soft magnetic materials is in transformers, where it is desirable to get a large change in magnetization by applying only a small magnetizing force. The student of physics will remember that the area enclosed by this hysteresis loop represents heat losses in the transformer — as it represents the energy which must be used to move the domains. Consequently, it is desirable to have a material that is very easy to magnetize — and conversely, to demagnetize.

It follows that the greater the energy required to magnetize a piece, the greater will be the energy required to demagnetize it. Therefore, large hysteresis loops are desired for permanent magnets, as the loop represents the amount of energy the magnet can store.

The demagnetization curve

It will be readily noted that the portion of the hysteresis loop below the $-H, +H$ axis is the exact opposite of the upper half. It merely represents the opposite polarity, or reverse magnetization. For permanent magnets it can be ignored. The first quadrant of the curve (the $+H$ portion) is only applicable while the magnet is being magnetized, and has no importance to permanent magnet operation after magnetization.* This means that only the second quadrant of the hysteresis loop, (from $+B_r$ to $-H_c$ in Figure 5) the **demagnetization curve**, is necessary to describe completely the magnetic characteristics of a permanent magnet.

Permeability

The magnitude of flux density produced is directly dependent on the magnetizing force, but is also dependent upon the medium in which the flux is measured. Certain materials offer less resistance, i.e., are more permeable, to flux than other materials. **Permeability** (μ) then is a measure of how much flux will be produced in a material by the application of a given magnetizing field. It is expressed as the mathematical ratio of the flux produced divided by the magnetizing field applied:

$$\mu = B/H \text{ or } B = \mu H.$$

The usefulness of a material in a magnetic circuit may be classified according to its permeability. A soft magnetic material, such as pure iron, has a very high permeability. This means even the application of a small magnetizing force will result in a large flux

density. The permeability of air is one; the application of one oersted of magnetizing force will result in a flux density of one gauss. For diamagnetic substances, the permeability is less than unity. For paramagnetic substances, it is greater than unity. For ferromagnetic substances, it is much higher. However, the value of permeability of all known diamagnetic substances is but slightly less than one, while the values of permeability for paramagnetic substances are only slightly greater than one.

For the purposes of most calculations, little error will be encountered if the permeability of all but the ferromagnetic materials is assumed to be one. In fact, it has become common practice to refer to anything in a magnetic circuit other than a ferromagnetic material as an **air gap**.

Permeability not only varies from material to material, but also varies within a material depending on the intensity of the applied field. If permeability were constant, the magnetization curve would be a straight line. The effect of three equal increments of magnetizing force, ΔH , ΔH_1 , and ΔH_2 , is shown graphically as ΔB , ΔB_1 , and ΔB_2 , in Figure 6. By definition, permeability is the amount of flux produced by a given magnetizing force. Since three equal amounts of applied field cause varying amounts of flux, it is obvious that the permeability is constantly changing. When the magnet is saturated, the permeability will become 1, or the same as air, and become a constant. When referring to permeability, it is always necessary to distinguish at what point it is measured.

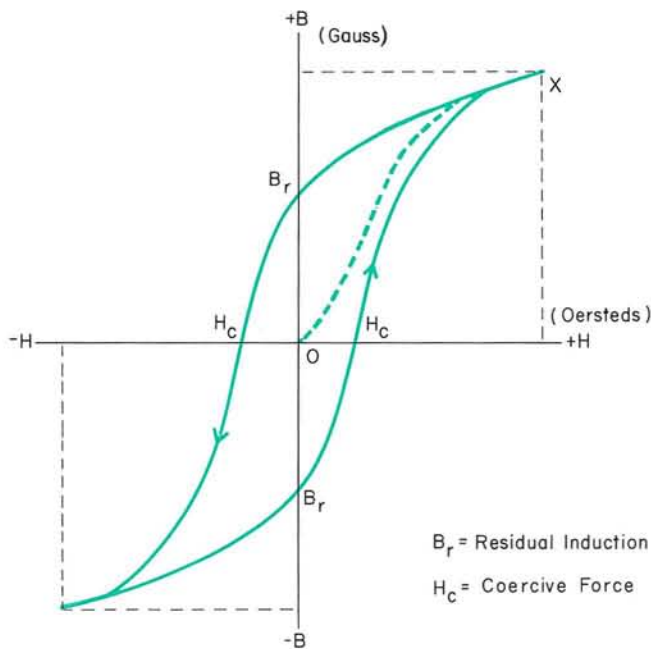

Fig. 5. Hysteresis loop plots flux measurement as magnetizing force is applied, withdrawn, reversed, withdrawn, and applied again.

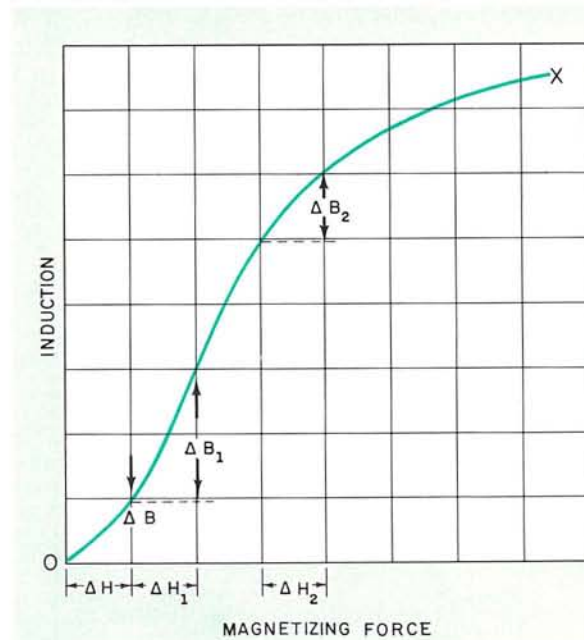

Fig. 6. Relationship between permeability and magnetizing force is graphically shown on magnetization curve above.

*In a few specialized applications, permanent magnets are used as hysteresis rotors and are alternately magnetized and demagnetized.

Intrinsic magnetic properties

The most distinguishing mark of a ferromagnetic material is the non-linear relationship between B and H . This is clearly seen in any hysteresis loop where an applied magnetizing force has caused a relatively large flux density (induction).

However, it should be noted that not all observed flux is produced by the magnet. If no ferromagnet were present, the magnetizing force of one oersted would produce an induction of one gauss. The observed flux, then, is the sum of the flux which would exist without the magnet, plus that produced by the magnet.

Flux density produced by the magnet alone is called the **intrinsic induction**, and can be found by simple arithmetic or by graphical means, as shown in Figure 7. The solid curve represents the total measured induction. The straight line at the lower right represents the induction of air. The dotted curve is the arithmetic difference between the two, and is the intrinsic induction (B_i) caused by the ferromagnetic material. Since the permeability of air is one, and $B = \mu H$, the induction due to air is at all times equal to the applied magnetizing force.

$$B = B_i + H \text{ or } B_i = B - H$$

It should be noted that in the first quadrant, normal induction is always greater than intrinsic induction. In the second quadrant (the demagnetizing curve), the intrinsic induction is greater. This is because of the negative value of H in the second quadrant.

Alnico and Lodex permanent magnets are characterized by values of intrinsic coercive force (H_{ci}) much lower than the residual magnetization (B_r). As a consequence, this class of permanent magnets have intrinsic and normal demagnetization curves differing very little. Until mid-century, little distinction was necessary. With the development of ferrite magnets where H_{ci} is of the same order as B_r , and the development of Hicorex where it is several times larger, we have magnets exhibiting a great distinction between normal and intrinsic properties. Intrinsic properties govern performance in many applications, particularly those where the magnet is placed in an external field to produce

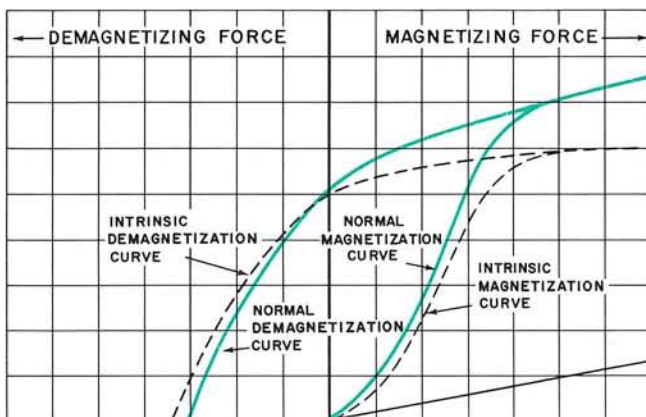

Fig. 7. Intrinsic induction (dotted curve) produced by a magnet alone is the arithmetic difference between total measured induction and the induction of air.

force or torque. These new materials with high H_{ci} values also have unit permeability; their leakage characteristics are different from the earlier class of materials, and they store and release energy quite differently when subjected to variable loads or air gaps.

Plotting the external energy curve

The **external energy curve** is obtained by plotting the product of the value of B and H for every point on the demagnetization curve. (It is conventional to refer to the value of B and H for a given point on the magnetization curve as B_d and H_d respectively.)

The energy available is zero at both the H_c and B_r points, and reaches a peak at a point known as the maximum energy product, or $(B_d H_d)_{max}$. The point at which the energy product peaks will be different for different grades of magnetic material.

For the most efficient utilization of magnetic material (that is, the smallest size magnet for a given output), a magnet should be designed to operate at the point of maximum energy. If B_d and H_d represent, respectively, the flux density in gauss and the demagnetizing force in oersteds, the expression $\frac{B_d H_d}{8\pi}$

ergs that each cubic centimeter of magnet material can supply for external use. The product of B_d and H_d is, therefore, proportional to the magnetic external energy, and it is accepted practice to describe the quality of a permanent magnet in terms of the maximum product of $B_d H_d$. The higher this product (expressed in gauss-oersteds), the stronger will be the magnet.

For convenience, the values of energy products are shown by means of a series of hyperbolic curves (as shown in Figure 8) which are superimposed on the demagnetization curve. The intersection of the demagnetization curve with the hyperbolic curves shows the available energy product at that point. The point at which the maximum available energy occurs is readily seen.

Although the factors concerned with the actual design of permanent magnets will be discussed in later pages, it will be well to consider permeance briefly at this point.

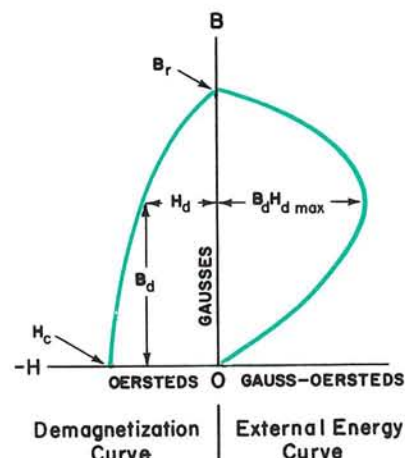

Permeance is a function of design

Permeance is simply a measure of how easy it is for the flux to pass from one pole through the air gap (external path) to the other pole. The higher the permeance, the easier the path, the higher the operating point, and the higher the flux density.

In describing the hysteresis loop, it was pointed out that after magnetization and before removal from the magnetizer, the magnet operates at B_r , or at the top of the curve. This is because the iron of the magnetizer provides a perfect path (or short circuit) for the flux flow. After the magnet is removed from the magnetizer, the flux now has to pass through the air to get to the other pole. This is not as easy a path as the iron of the magnetizer; less flux will flow, and the operating point will fall down to the left. How far down the curve it falls will be determined by the shape of the magnet.

The operating point of a long slender magnet will be high on the curve; hence the magnet will operate at a high level of induction. Short stubby magnets fall farther down the curve and have lower induction. Thus, the higher the length to diameter ratio (L/D), the higher the operating point of the magnet. (Length always refers to the direction of magnetization, while the diameter is the effective diameter of the cross-sectional area at right angles to the length.)

Permeance is not a function of the magnet material, but is strictly determined by the geometry of the magnet circuit. The permeance coefficient is the slope ($-B/H$) of the line (OA) drawn from the magnet's operating point on the demagnetization curve to the origin (as shown in Figure 8), while the line itself is called the operating **load line**.

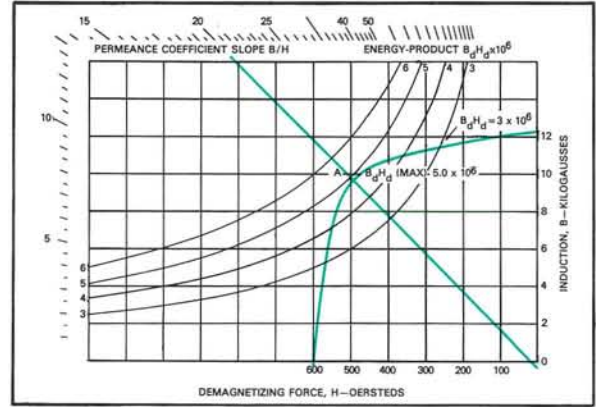

Fig. 8. The intersection of the demagnetization and energy-product curves shows the point at which maximum energy is available for a given magnetic material.

How to determine best material

Figure 9 shows how the operating load line is used to determine the best material for a given application. Curves of both Alnico 5 and Alnico 8 are drawn on the same plot and the operating load lines OY and OX for two hypothetical magnet designs are superimposed. (Remember, these load lines are merely graphic representations of the permeance.)

It will be readily seen that when an Alnico 5 magnet and an Alnico 8 magnet are subjected to the same permeance shown by the load line OX (Figure 9), Alnico 5 will produce an amount of flux equal to point X , while Alnico 8 will produce an amount equal to X' . In the case of the load line OY , Alnico 8 will produce more flux

It will also be noted that Alnico 5 develops its maximum energy at a high level of induction, while Alnico 8 develops its maximum product at a lower level of induction. This inherent difference in the properties of the materials accounts for the reason Alnico 5 will be superior to Alnico 8 in designs where the induction is high, while Alnico 8 will be better at low induction levels.

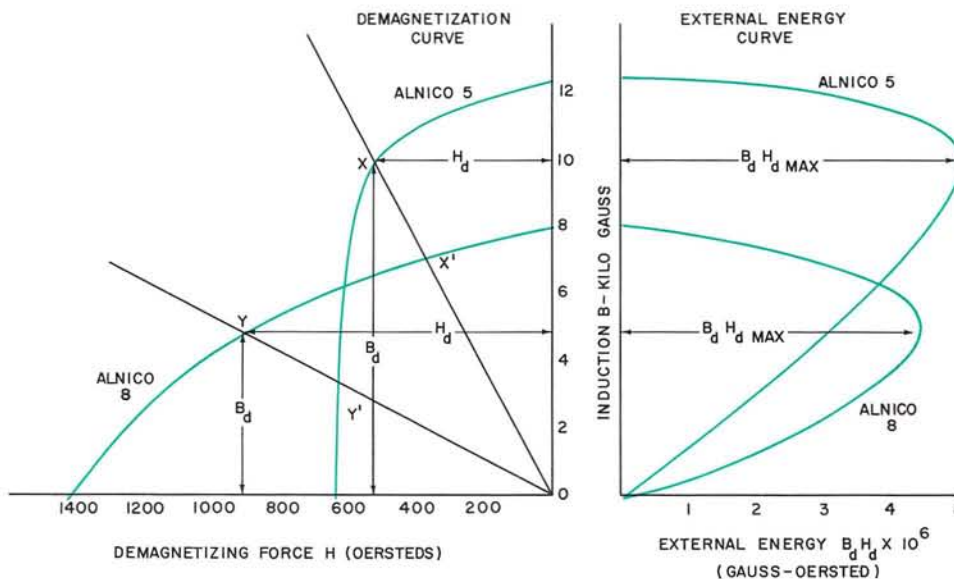

Fig. 9. The intersection of the operating load lines and demagnetization curves shows where the maximum flux and energy are produced for Alnico 5 and Alnico 8.

Permanent Magnet Materials

Many magnetic materials are available. Knowledge and careful analysis is needed to make the right choice.

As one reviews the history of permanent magnet materials, it is interesting to note how improvements in unit properties have influenced magneto-electric and magnetomechanical equipments and devices. The first uses of the permanent magnet were in applications where a permanent magnet was truly a necessity. The compass, the magnetometer, and the D'Arsonval meter were the first applications of early magnets. The weak fields from rather excessive volumes were tolerated in these first uses. With each significant increase in properties, designers have explored the possibility of improving an existing permanent magnet design or replacing electromagnetic excitation. Permanent magnets are high leverage components that have great impact on the size, efficiency, stability, and cost of a great number of devices.

Early Steel Magnets

Man's first attempt to improve on the natural lodestone involved compositional changes in early steel. It was a significant discovery that additions of cobalt improved the coercivity to the 200-300 oersted range and the permanent magnet became an industrial component of considerable interest.

Alnico

Isotropic Alnico magnets were developed in the early 1930's. The level of coercive force was essentially doubled and good structural stability was achieved. Permanent magnets for the first time were truly permanent under such adverse environmental conditions as stray fields, shock, and elevated temperature.

The development of anisotropic Alnico just prior to 1940 was truly a remarkable milestone in permanent magnet technology. The energy product was improved by a factor of four with a simple process addition: cooling in a magnetic field. For the first time, permanent magnets surpassed electromagnets in terms of volumetric efficiency. The new properties quickly found use in loudspeakers and the size of the permanent magnet industry grew substantially.

Cast anisotropic Alnico magnets are still the largest commercially produced group of permanent magnet materials. Major improvements of the coercive force by alloy additions, and improved orientation by controlling the crystal structure during casting, have been achieved. Alnico 5-DG and Alnico 5-7 are examples of improved properties made possible by controlled crystal structure. Alnico 6 and Alnico 8 are examples of the progress in alloying additions to improve coercive force. The cast magnet forming process is most effective when used to produce relatively large simple shaped magnets in large volume, because casting as a technique for forming

metal is economical. The properties of cast anisotropic magnets are ideally suited to magnetic circuits having high permeance gaps. The best induction properties are achievable in cast anisotropic magnets.

Sintered Alnico magnets have features which make them especially suitable in very small precision devices. The mechanical strength and tolerances are improved over cast Alnico magnets. It is possible to sinter magnets with small holes and intricate shapes. In very small sizes sintered magnets are generally less costly than cast magnets due to the nature of the process techniques involved. Sintered magnets are available in both isotropic and anisotropic form and with a wide range of unit properties. Their magnetic properties are essentially like the cast magnets of equivalent grade.

Lodex®

Lodex permanent magnets represent a remarkable new sequence of process events in magnet-making. The fine particles are formed by electroplating from an iron-cobalt anode into a mercury cathode. Under controlled plating cell conditions, elongated single domain regions are formed. These unique fine particles are coated with a lead matrix and the mercury is removed. The resulting magnetic material is then ground to fine powder and pressed at room temperature in die systems to make both isotropic and anisotropic grades of Lodex. There are no elevated temperature cycles involved, and consequently magnets are produced to very close mechanical and magnetic tolerances. Like sintered magnets, Lodex magnets are most economical in relatively small sizes and where tolerances and mechanical features are key considerations. The magnetic properties of Lodex are easily changed by adjusting the ratio of iron cobalt to lead matrix. Lodex magnets are also offered in three grades made by extrusion forming. Lodex magnets are the first high coercive force magnets developed which are machineable.

Ceramic Permanent Magnets

A new class of ceramic permanent magnets was announced in 1952. The coercive force of the ceramic magnets result from the high crystal anisotropy of barium and strontium iron oxide. The very high resistance to demagnetization, coupled with the inexpensive and non-strategic raw materials, have made this class of permanent magnets attractive in magnetic circuit and device uses.

The material is available in isotropic and anisotropic grades. The isotropic grade is produced by pressing the mixed raw materials to shape and sintering at elevated temperatures. The anisotropic grades developed in 1954 are prepared by prefiring raw materials and milling the resulting compound

into single crystals approximating a single domain in size. The milled powder is then wet or dry pressed in a die under the orienting influence of a magnetic field. The pressed compacts are then sintered at elevated temperatures. Careful control of particle size, composition and density permit the production of several anisotropic grades which differ in terms of energy product and coercive force.

Ceramic magnets are very hard and brittle and must be ground to maintain close mechanical tolerances. Several varieties of rubber and plastic bonded ceramic magnets are available with more acceptable physical properties but with considerable sacrifice in magnetic properties. Ceramic mag-

nets differ from metallic magnets in terms of their resistivity. Ceramic magnets are virtually electrical insulators at room temperature and hence, in applications where high frequency fields are present, they are a good choice.

The physical density of ceramic magnets is of the order of half that of many metallic magnets and, so, compare rather favorably when evaluated on the basis of magnetic field energy per unit of weight. Ceramic magnets, due to their high m.m.f. and relatively low induction, are characteristically of large cross sectional area and short dimension in the axis of magnetization.

Properties of Hicorex 90, 96, and 99

During the past decade the unit properties of Hicorex permanent magnets have improved substantially. New alloys of higher unit properties have been developed. A host of new alloys with different sets of properties suited to specific applications have been introduced in the market. The above progress in material development has resulted in the use of Hicorex in a number of devices where alnico and ceramic were virtually impossible to function.

The unit properties of Hicorex permanent magnets are markedly different than those of alnico and ceramic materials. A one to one replacement of alnico or ceramic by Hicorex will be very expensive and at times detrimental to system performance. It is very important for the designer to have a good knowledge of the magnetic properties of Hicorex before designing a system.

The following are some key properties of Hicorex and their associated advantages in systems design.

Maximum Energy Product (BH) max:

The high energy product (5-6 times that of ceramic and 3-4 times that of alnico) allows the system to use a much smaller volume of magnet, thus miniaturizing the size of the system, increasing the system torque or force to inertia ratio, and reducing the system mechanical time constant.

Remanence Br

The values of remanence in Hicorex permanent magnets range from 8200 gauss to around 10600 gauss depending on the specific alloy. This high value of induction results in high flux density in the gap thus improving torque, output power, efficiency and force constant of dynamic devices.

Intrinsic and Normal Coercivity, Hci, Hc

Hicorex has very high coercive force. The intrinsic coercivity (Hci) of Hicorex is up to 30 times higher than alnico and 10 times higher than ceramic. This property

makes the magnet virtually immune to accidental demagnetizing effect. It allows the designer to use thin magnets (in the direction of magnetization) in his device. It makes the magnet less prone to demagnetizing effect in repulsion mode devices. It allows the designer to magnetize the magnet and then assemble it into his device without using a keeper as is conventionally done with some grades of alnico.

Thermal Characteristics

In contrast to ceramic magnets, the coercivity of Hicorex magnets increases at low temperature (below room temperature). Like ceramic and alnico the induction value of Hicorex increases with decreasing temperature and decreases with increasing temperature.

At temperature above 24°C Hicorex 90 suffers .04%/°C reversible loss. The decrease in intrinsic coercivity (Hci), however amounts to .4%/°C.

Scientists have measured rare earth cobalt magnets at 7°K (kelvin) to exhibit 64 MgOe. This same magnet exhibited only 15 MgOe at room temperature.

Primary Application Areas of Hicorex

Hicorex permanent magnets are being used in a broad spectrum of devices ranging from a small cube (less than 0.5 mg) for a Hall effect biasing magnet to more than a 250 gram block for a torque motor used in medical application. The following are some typical areas of application of Hicorex permanent magnets.

Motors

Small servo motors, step motors, basket motors, inside out motors, pancake motors, synchronous motors, etc.

Generators

Small radial and tangential generators.

Voice Coil Actuators (VC)

VC actuators for small speakers, head-sets, computer head positioning of linear, rotary and limited motion types.

Impact Printers

Line printers, dot matrix printers and hybrid (line/matrix) printers.

Sensors

Hall effect, reed switch and some mercury proximity switches.

Couplings

Used in radial, axial or linear couplings.

Microwave Devices

Used in TWT's, magnetrons and isolators.

Inertial Devices

Used in gyros and a host of missile guidance systems.

Medical Devices

Brain scanner and computer axial tomography (cat) scanner.

Notes on Magnetization and Demagnetization of Hicorex Magnets

Magnetization

Hicorex has the highest anisotropy field of any hard magnetic material commercially available today. Therefore, Hicorex needs to be magnetized at a substantially higher magnetic field strength than that required for alnico and ceramic.

Hicorex magnets can be magnetized to around 98-99% of their theoretical saturation values using DC or pulsed field of 15,000-25,000 oersteds. The period of the pulse should be no less than 20m sec., and the magnet should be in a closed magnetic circuit (nearly zero gap) during magnetizing in both cases.

Note that if an air gap is formed between the magnet and one of the pole pieces, the self demagnetizing force acting on the magnet will increase the field requirement for saturation. For more detail the manufacturer should be consulted.

Demagnetization

As stated earlier, Hicorex has a very high anisotropy field. This characteristic makes it difficult to demagnetize the magnet beyond a specific level after it has been magnetized.

It is nearly impossible to **field demagnetize** (to zero magnetization) the typical Hicorex 90 or 96 magnet. The only effective method for accomplishing complete demagnetization of Hicorex 90 or 96 is to heat the magnet above its Curie Point (around 750°C) in controlled atmosphere. However, this will substantially reduce the magnetic property of the magnet unless proper reheat treatment steps are to follow. Therefore, the manufacturer should be consulted when demagnetizing is required. The Hicorex 99 grades can be field demagnetized using fields equal to the intrinsic coercive force. This feature is an advantage in some applications where the ability to demagnetize is important. However, these grades provide less protection against demagnetization. Their use as a substitute for the Hicorex 90 grades should be reviewed with the manufacturer.

Manufacturability as a Function of Magnet Geometry

Within a given alloy, the desired geometry of a magnet dictates its magnetic properties to a great extent. In order to achieve maximum properties for a given Hicorex alloy (or any other rare earth cobalt permanent magnets), the powder is aligned in a magnetic field just prior to compaction in the press. The degree of alignment is a function of the level of alignment field. There are two distinctly different methods of alignment as described in the following paragraphs.

1. Parallel Alignment

In this method the alignment field is parallel to the direction of pressing. The alignment field is produced by a solenoid (coil) placed around a die system in the press. Fig (1) demonstrates this method schematically.

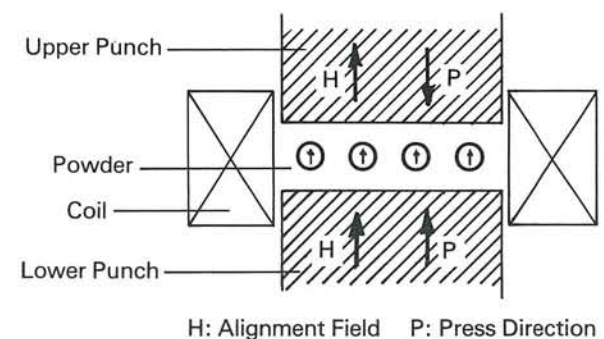

Fig. 10a.

2. Perpendicular Alignment

The alignment field in this method is generated by an electromagnet whose poles are placed against the outside walls of the die system (fig. 2). The direction of alignment is perpendicular to the direction of pressing. No die system shown.

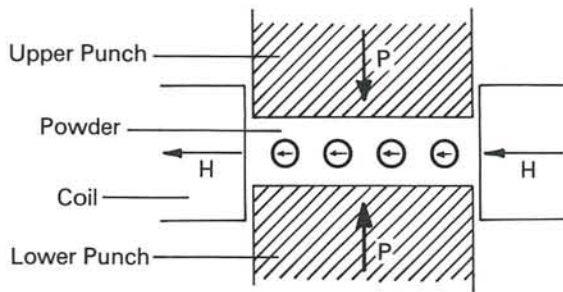

Fig. 10b. H: Alignment P: Direction of Press

Using a given alloy (for example Sm Co5), the magnet will exhibit higher magnetic properties using perpendicular alignment rather than using parallel alignment.

Examining the two methods of alignment one can see that there are **limitations on the configuration of the magnets if perpendicular alignment is to be used**. For example an axially aligned ring magnet can not be manufactured using the perpendicular technique of alignment. Therefore it is necessary to consider the shape of the magnet to be used when designing a magnetic circuit to be sure that the desired magnetic properties can be obtained. See magnetic properties of H-90A vs H-90B and H-99A vs H-99B (page 32). Please contact manufacturer for further details.

Hicorex™ (Rare Earth-Cobalt Magnets)

Hicorex magnets represent a tremendous step forward in energy product and coercive force. In the intermetallic compounds of rare earth elements and cobalt, the attachment of the magnetization to the crystal axis has resulted in record levels of coercive force, a ten-fold improvement over ceramic magnets. These magnets are sintered and always oriented since magnetization would be virtually impossible without a well oriented magnet structure.

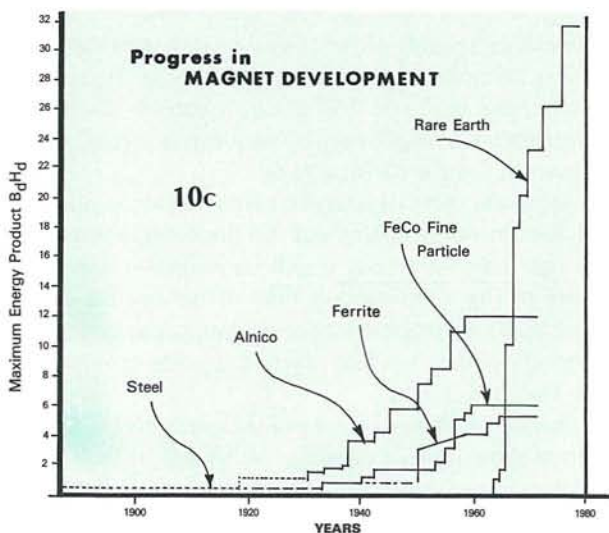

The very large magnetic moment per unit volume of this class of materials, coupled with the great resistance to demagnetization, make it possible to invert the design of many devices. Moving magnet meters, loudspeakers, actuators, and motors are presently under development. Rare earth magnets promise to have major impact on a number of equipments and devices. New device concepts and continued progress in reducing the cost of the rare earth elements will allow these magnets to become widely used.

Iron Chromium Cobalt (Fe Cr Co)

The most recent addition to the family of permanent magnets (commercially viable) is Iron Chromium Cobalt alloy.

The magnetic properties of the Fe-Cr-Co system depends on the spinodal microstructure, which consists of Fe rich alpha 1 and Cr rich alpha 2 phases.

The alloy is cast, solution annealed, quenched and subjected to an isothermal magnetic field treatment after which it is step aged. The magnetic field treatment essentially doubles the energy product of the magnet.

Fe Cr Co alloy has properties which essentially fall between those of cast random Alnico 5 and columnar Alnico 5. However, the cobalt content used in this alloy is reported to be anywhere between 8-13% (vs 24% for alnico).

This alloy is available from Hitachi Magnetics Corporation in certain configurations. Typical magnetic and physical properties of the alloy are shown (page 32).

Property Data

The back pages of this manual shows the typical magnetic and physical properties of the permanent magnet materials offered by Hitachi Magnetics Corp. Some complete demagnetization curves are shown illustrating the very wide choice of unit properties available. This chart can serve as a convenient worksheet for graphical analysis and comparison of alternate property and geometry combinations. Refer to the individual product line brochures for more complete data.

The One Best Solution

The design of a permanent magnet for a particular application involves a number of complex relationships. The choice of permanent magnet material and its magnetic circuit arrangement are predominantly affected by cost, volumetric efficiency, stability, physical strength, or a combination of these factors. The cost depends not only on the magnetic material chosen but also on its size, shape, tolerances, finishing required, and the quantity ordered.

As a general rule, the sintered Alnico magnets and the Lodex magnets offer the best solution for small, intricately shaped, close-tolerance, electromechan-

Figure 10c, at left, shows the property improvement of permanent magnets with time. The rate of improvement has been significant since 1940. (Values are best properties achieved in laboratory.)

ical device problems. Lodex permanent magnets have the distinct advantage of being formed by cold pressing techniques and thus to very close tolerances. Where a large magnet is involved, it is generally most economical to form the magnet by casting if there is a choice. Designers have, to a large extent, utilized the very best permanent magnet properties available in spite of their higher cost. The reason for

this is that the high-quality permanent magnet leads to a smaller and more efficient device or equipment. Hicorex permanent magnets are examples of a major change in properties, and many new device concepts are possible which can have great influence on the performance features and worth of the device. Such change can, in many instances, justify the higher cost of these new magnets.

Energy and Permanent Magnets

Only when there is a change in the balance of internal energies is energy released or absorbed by the permanent magnet.

The permanent magnet can be thought of as a grouping of domains, a domain being the smallest region in which atoms have a common magnetic moment. In the completely demagnetized condition, domain boundaries and orientations are so arranged that internal paths exist and the external or magnetostatic energy is zero.

In general, any fields used to magnetize or demagnetize materials only change the balance of the much larger internal energies. This leads to one of the most fundamental and important laws of permanent magnets: No energy is required to maintain a magnetic field. Only when there is a change in the balance of the internal energies, resulting in a change of magnetization, is energy either absorbed or released by the permanent magnet. Magnets are then intrinsically stable, and some form of external work must be done to alter the magnetic field.

The mechanism by which permanent magnets establish external field energy is shown pictorially in Figure 11 where the movement of domains, shown as arrows, is indicated for various stages of magnetization.

At (a) there is no external field, because the domains, although fully magnetized, satisfy minimum energy requirements by taking positions that form closed magnetic circuits within the material.

At (b), under the influence of a high external field, the domains are rotated against the forces of anisotropy into the direction of the field. The external energy, extracted from the magnetizing field, is shown graphically as the area enclosed by OAB_S .

At (c), the magnetizing field has been reduced to zero, and the magnetic moments of the domains rotate back to easy direction of magnetization. At this point, a new minimum-energy balance is achieved, but since the size and shape of the domains have changed during magnetization, this minimum energy balance cannot be satisfied by internal paths. The result is an external field which establishes flux equal to B_r . Area AB_rB_S represents the energy returned from the magnet to the electrical circuit, while area OAB_r represents the work done in rearranging the domains. At this point, no external field energy is available.

At (d), a gap is introduced at each end of the magnet by pulling it from the iron core. The domains near the end of the magnet change their orientation due to the imbalance created by the in-

creased reluctance, taking positions essentially 180° from their direction in (c). Mechanical energy is required to pull the magnet from the magnetizer. This energy is proportional to area ODB_r on the hysteresis loop, and is the potential energy of the system. Area TDB_r represents the potential energy stored in the magnet, while ODT represents available energy stored in space surrounding the magnet.

Finally, at (e) the magnet is returned to the iron core, reducing the gap to zero. Mechanical work will be done by the magnet, and the operating point will recoil from D to S . The domains near the poles will revert to nearly the same positions as in (c). The potential energy stored in the external field and within the magnet will have been converted to mechanical work in returning the magnet to the magnetizer.

It will be noted that the operating point did not return to B_r , but rather to a lower level of induction designated by S on the loop. As the magnet is cycled back and forth, a minor hysteresis loop will be traced from point D to point S . In this simple example, it can be seen how mechanical work is converted to magnetic field energy, and how this magnetic field energy can be converted back to mechanical energy.

Self-demagnetization

The most important concept peculiar to permanent magnets is that of self-demagnetization, or the rotation of the domains near the ends of the magnet. The preceding example has shown how this rotation stores energy within the magnet. It is this effect which accounts for the main difference between permanent magnets and electromagnets; namely, magnets have negative magnetomotive force OH as shown in Figure 11 (d) and (e).

Since the mmf of a permanent magnet is due to the rotation of domains against their original direction of magnetization, it will be negative with respect to the magnetizing field. (This can be seen from the fact that permanent magnets operate in the second quadrant, while electromagnets operate in the first quadrant.)

This self-inflicted demagnetization is also a function of the shape of the magnet. Its influence is at a minimum in a long, slender magnet, and at a maximum in a short magnet with a large cross section.

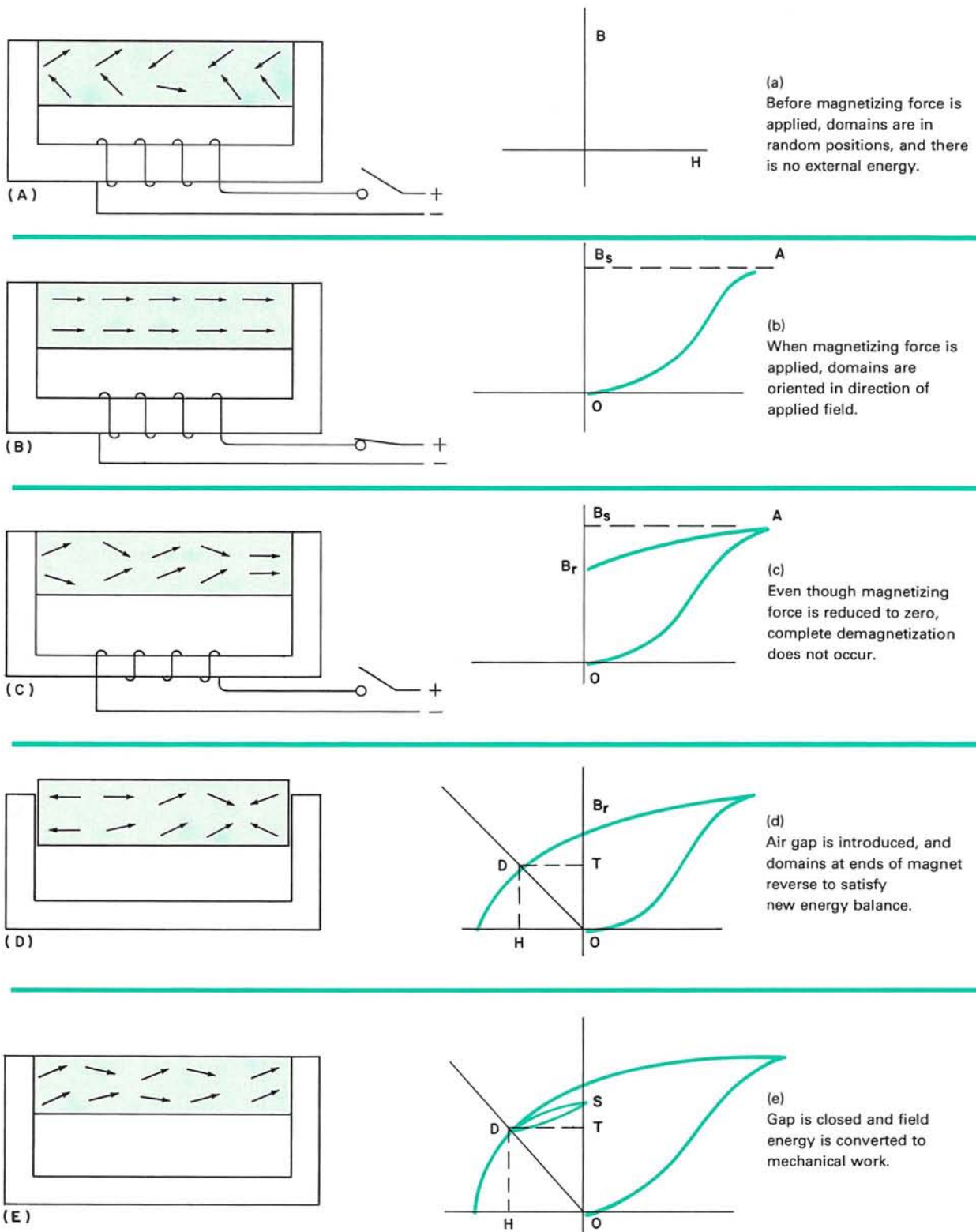

Fig. 11. Graphic conception of permanent-magnet domains under various conditions.

Magnet Design

It is the shape of a permanent magnet which influences the amount of flux produced.

The basic purpose of any magnet is to store energy or to convert energy from one form to another. This is generally achieved by setting up a magnetic field at some point in space commonly called the air gap, or by storing the energy within the magnetic material.

The design of permanent magnets is complicated by many factors, two of which are: (1) the elusive qualities of flux; (2) equal volumes of magnetic material will produce different amounts of flux depending on their shape.

In electrical circuits, current can be made to flow through definite paths called conductors. This is true because some materials offer little resistance to the flow of current, while others offer high resistance. In fact, some materials are insulators, and completely block the flow of current. There are no materials which will block the flow of flux in a magnetic circuit, so we cannot direct it as conveniently.

The magnetic circuit

The magnetic circuit may be divided into two parts:

- (1) The permanent magnet itself, which supplies the **magnetomotive** or driving force;
- (2) The path the flux takes in getting from one pole of the magnet to the other.

Since there are no magnetic insulators, it can be

seen how difficult it is to direct flux to those parts of the magnetic circuit where it can be usefully applied. The flux produced by a permanent magnet may be divided into two groups: useful flux, and leakage flux. The fundamental problem in circuit design is to minimize the unavoidable **flux leakage** to improve the efficiency of the circuit.

How to design for maximum energy

For efficient use of magnetic material, the magnet should be designed to operate at the flux density where the available external energy $B_d H_d$ is at maximum. There is a simple construction shown in Figure 12 which will quickly locate this approximate point. A straight line drawn between the coordinates of B_r and H_c , and the origin will intersect the demagnetization curve at the point of maximum energy. The exact location of the maximum energy product can only be determined by plotting BH products and graphically determining the point where BH goes through a maximum.

The permanent magnet can be designed to operate at this optimum point by using the corresponding values of H_d and B_d obtained from the demagnetization curve of the desired magnetic material. These values can be applied in the formulae on the following page to find the length and area of the magnet when the required flux density and dimension of the air gap are known.

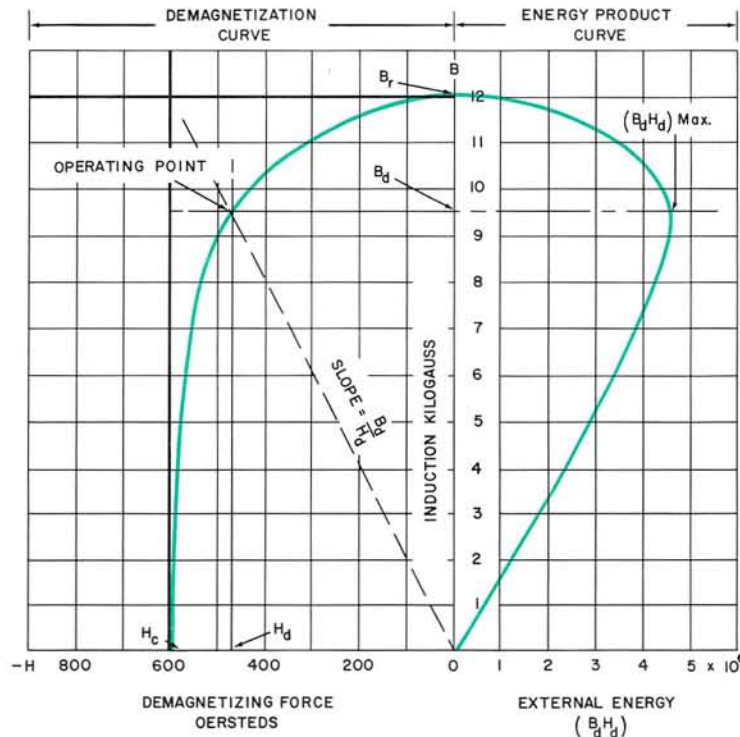

Fig. 12. For maximum energy, a magnet should be designed to operate at the flux density where the line drawn from the origin to the coordinates of B_r and H_c intersects the demagnetization curve.

Design Formulas

1-HOW TO DETERMINE MAGNET LENGTH

$$L_m = \frac{B_g L_g}{H_d}$$

where L_m = necessary length (cm.) of magnet
 B_g = flux density (gauss) desired in the air gap
 (equal numerically to H_g , in air)
 L_g = length (cm.) of the air gap parallel to lines
 of flux
 H_d = magnetizing force (oersteds) of the magnet,
 corresponding to the operating point on
 the demagnetization curve.

2-HOW TO DETERMINE MAGNET AREA

$$A_m = \frac{B_g A_g}{B_d}$$

where A_m = necessary area (square cm.) of magnet
 perpendicular to direction of magnetization
 B_g = flux density (gauss) desired in the air gap
 (equal numerically to H_g , in air)
 A_g = cross sectional area (square cm.) of the air gap
 perpendicular to lines of flux
 B_d = flux density (gauss) of the magnet,
 corresponding to the operating point of the
 demagnetization curve.

Design Problems

EXAMPLE 1

Find the length and area of a permanent magnet (neglect leakage flux) which will establish a specified flux density through an air gap of known dimensions.

Let: $B_g = 5000$ gauss
 $A_g = 2$ square cm.
 $L_g = 0.5$ cm.

and from the curve in Figure 12 where $B_d H_d$ is at a maximum:

$B_d = 9500$ gauss
 $H_d = 475$ oersteds

and substituting in the given formula:

$$L_m = \frac{B_g L_g}{H_d} = \frac{5000 \times 0.5}{475} = 5.26 \text{ cm.}$$

$$A_m = \frac{B_g A_g}{B_d} = \frac{5000 \times 2}{9500} = 1.05 \text{ sq. cm.}$$

3-HOW TO DETERMINE LOAD LINE

If the size and shape of the magnet are established, its load line, B/H , can be found as follows:

$$A_m = \frac{B_g A_g}{B_d} \quad \text{therefore, } B_d = \frac{B_g A_g}{A_m}$$

$$L_m = \frac{B_g L_g}{H_d} \quad \text{therefore, } H_d = \frac{B_g L_g}{L_m}$$

Combining the two equations:

$$\frac{B_d}{H_d} = \frac{\frac{B_g A_g}{A_m}}{\frac{B_g L_g}{L_m}} = \frac{A_g L_m}{A_m L_g}$$

4-HOW TO DETERMINE FLUX DENSITY

Draw a line having a slope of B_d/H_d through the origin and the second quadrant as shown in Figure 12. Read the value of B_d where this line intersects the demagnetization curve and substitute this value in the following formula:

$$B_g = \frac{A_m B_d}{A_g}$$

EXAMPLE 2

Calculate the flux density in an air gap when the dimensions of the magnet and circuit are known (neglect flux leakage).

Using the same dimensions as in the preceding problem.

Let: $L_m = 5.26$ cm.
 $A_m = 1.05$ sq. cm.
 $A_g = 2$ sq. cm.
 $L_g = 0.5$ cm.

$$\frac{B_d}{H_d} = \frac{A_g L_m}{A_m L_g} = \frac{2 \times 5.26}{1.05 \times 0.5} = \frac{10.52}{0.525} = \frac{10,520}{525}$$

Draw a straight line of the demagnetization curve through the origin and the point where $B = 10,520$, $H = 525$.

Read B_d where this line intersects the demagnetization curve. (See Figure 12.)

$$B_d = 9500 \text{ gauss}$$

Permeance calculations

Permeance is a measure of conduction or the ease of establishing flux between two regions. For convenience in magnet design, the total permeance P_t is divided into two parts: Gap permeance P_g (or useful permeance) and limb permeance P_l (or unavoidable leakage permeance). The fundamental law of magnet design (the magnetic analog Of Ohm's Law) is:

Flux = Magnetomotive force x total permeance

$$\phi = \text{mmf} \cdot P_t$$

Since $\phi = BA_m$ (flux density times magnet area)
 $\text{mmf} = HL_m$ (unit magnetizing force times length of magnet)

and $P_t = P_l + P_g$ (leakage permeance + gap permeance)

$$BA_m = HL_m (P_l + P_g)$$

$$\text{or } B/H = \frac{L_m}{A_m} (P_l + P_g)$$

For an open-circuit magnet with no defined air gap, all the permeance is leakage permeance. This leakage permeance is a function of the exposed limb area for surface. A convenient engineering approximation for permeance as a function of area is:

$$P_l = 1.77\sqrt{S} \quad \text{Where } S = \text{the exposed surface area of the magnet limb or } \frac{1}{2} \text{ the total surface area of the magnet}$$

$$\text{and } B/H = \frac{L_m}{A_m} \times 1.77\sqrt{S}$$

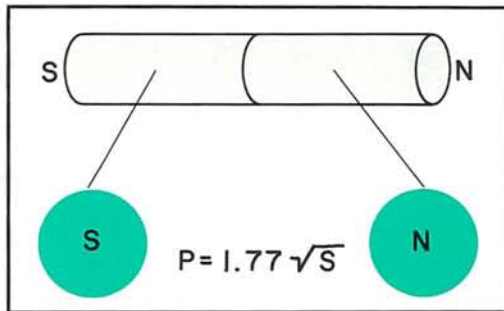

Fig. 13. Each limb or surface of a magnet may be thought of as a spherical pole.

This relationship is based on the premise that each limb of the magnet may be thought of as a spherical pole whose surface is the same as the surface of the limb. In most cases, the center of the effective pole is not located at the physical end; therefore, an adjustment for the effective length (L_e) of the magnet must be made. In most commercial materials, this effective pole spacing can be considered 0.7 of the length (L_m).^{*} The useful formula then becomes:

$$B/H = L_e \times \frac{L_m}{A_m} \cdot 1.77\sqrt{S} =$$

$$.7 \frac{L_m}{A_m} \cdot 1.77\sqrt{S} = 1.24 \frac{L_m}{A_m} \sqrt{S}$$

^{*}Notable exceptions are barium ferrite and rare earth cobalt, where pole spacing is essentially the full length of the magnet.

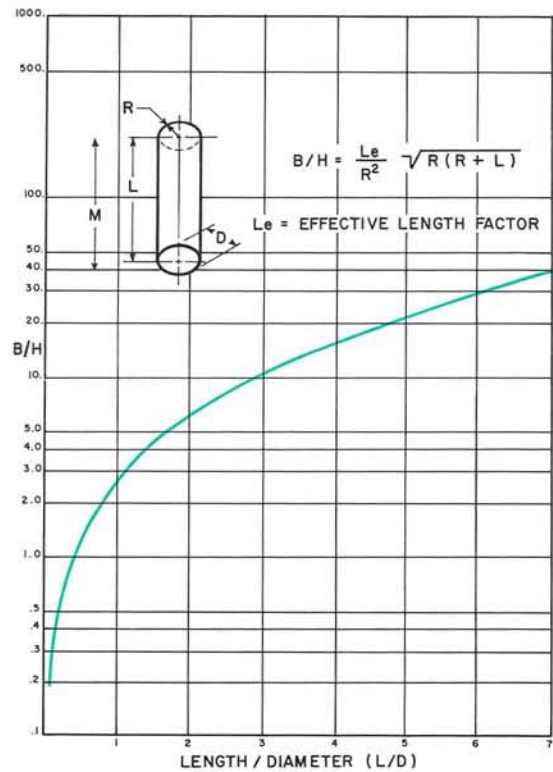

Fig. 14. Demagnetizing coefficients for rod magnets with axial magnetization.

This fairly universal formula, applicable to a wide variety of magnet configurations, has been used to plot the curves in Figures 14-16, which graphically show the relation of magnet configuration and permeance. On each curve, the formula is given so values not plotted may be calculated. All are variations of the basic formula, with adjustments to account for the exposed surface area.

If the same magnet is now bent into a U or C configuration as in Figure 17, the poles are moved closer together and there will be a definite exchange of flux in a region called the air gap. The free pole concept is no longer correct, since the permeance of the air gap will now have a greater effect. The analysis must be modified to include this additional permeance, which is a function of gap geometry. For very small air gaps, it can be expressed as the area of the gap (A_g) divided by the length of the gap (L_g), and the permeance formula becomes:

$$B/H = .7 \frac{L_m}{A_m} \left[1.77\sqrt{S} + \frac{A_g}{L_g} \right]$$

Gap permeance does not follow a linear relation with A_g/L_g ; a modification must be made as the length of the gap is increased. The curve in Figure 17 shows how this varies. For long gaps, it is necessary to find the gap permeance as a function of gap geometry from this curve and substitute this in the permeance equation.

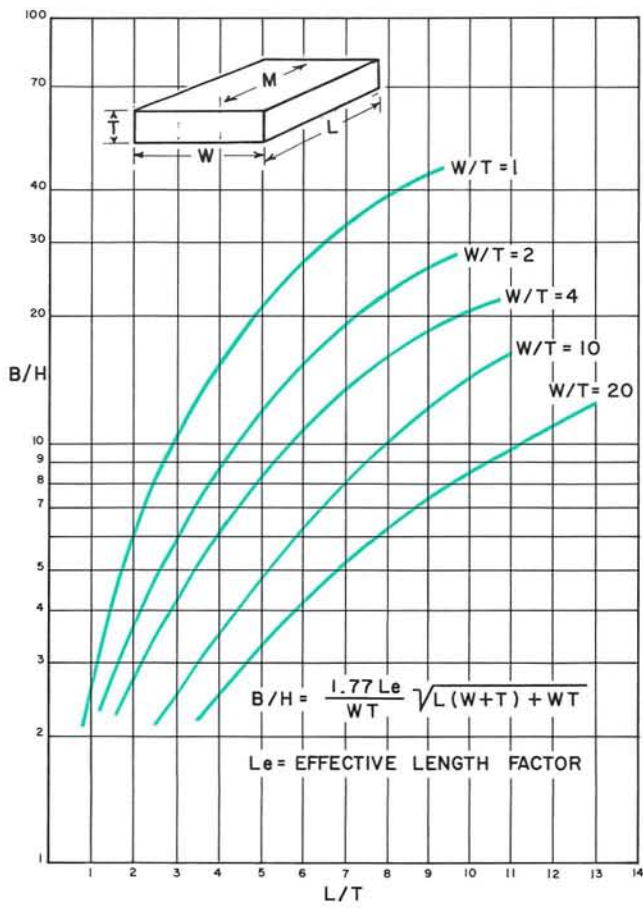

Fig. 15. Demagnetizing coefficients for bar magnets.

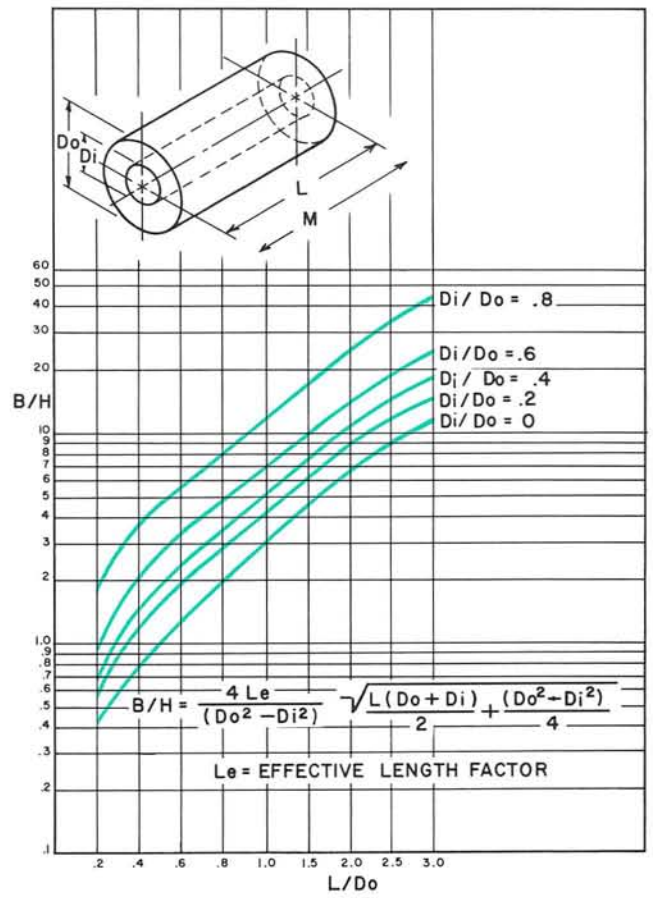

Fig. 16. Demagnetizing coefficients for ring magnets with axial magnetization.

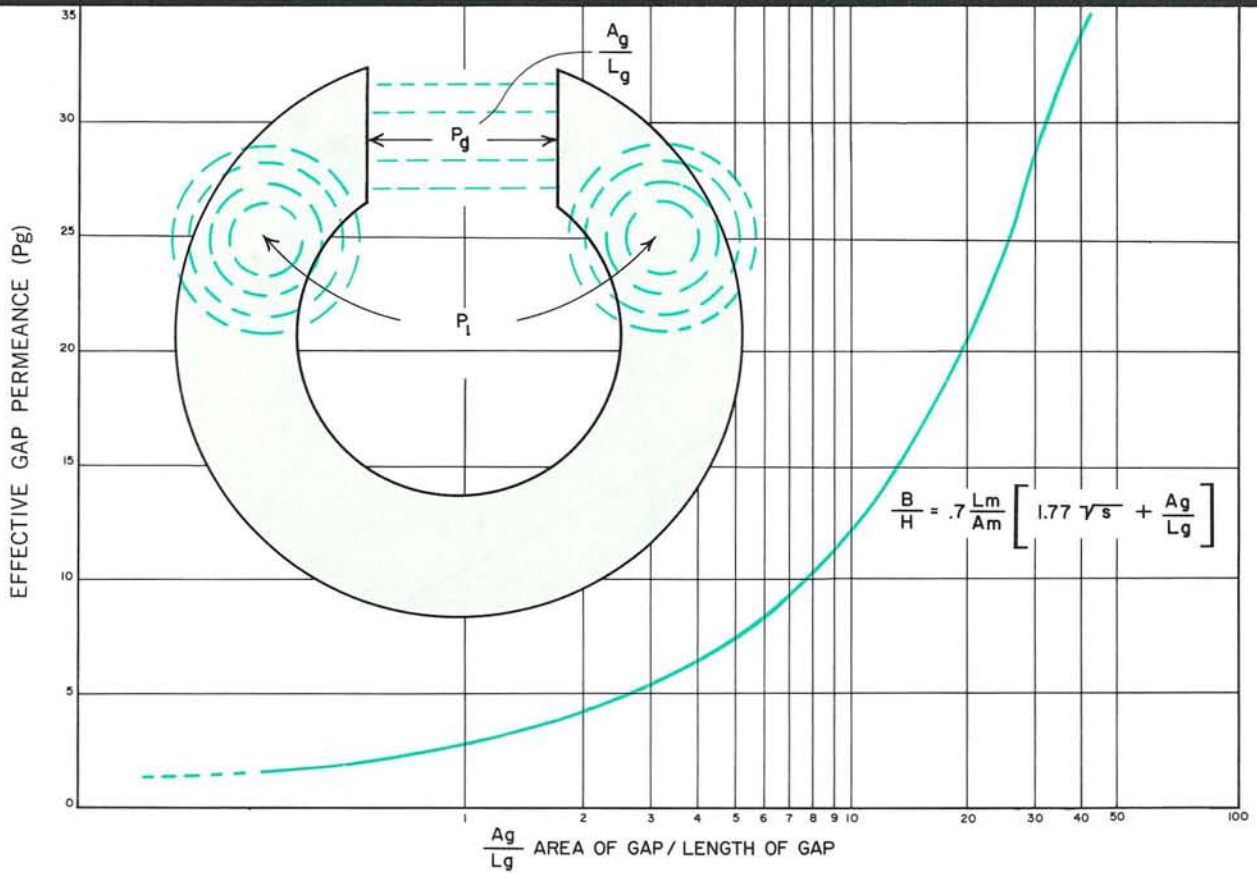

Fig. 17. Permeance for air gaps of a circular section as a function of the gap geometry.

Calculating flux leakage

The magnet establishes and conducts both useful and leakage flux. The shape of the magnet and its magnetic circuit determine flux leakage. The design formula may be modified to account for this by introduction of leakage factors f and F as follows:

$$L_m = \frac{fBgLg}{Hd}$$

$$\text{where } f = \frac{\text{Magnet magnetomotive force}}{\text{Gap magnetomotive force}}$$

$$A_m = \frac{FBgAg}{Bd}$$

$$\text{where } F = \frac{\text{Total flux required for circuit}}{\text{Useful air gap flux}}$$

The factor f adjusts for the fact that magnetomotive force per unit length in both the magnet and gap is not constant; and usually varies between 1.0 for very small gaps to 1.5 for very large gaps. The leakage factor F is a ratio of the total permeance to gap permeance, and varies from 1.05 to 20.

It can be seen readily that design problems would be simple if the values of f and F were known. However; their calculation is difficult; in many cases trial and error may be necessary. In general, the actual calculation of leakage flux for a typical magnet design is

lengthy and complicated; so the design is usually an "empirical" process for which considerable experience is necessary.

Circuit permeance

In Figures 13-16, the magnets are in the open-circuit condition (with no pole pieces), and permeance is strictly a function of magnet geometry.

When assembled in a magnetic circuit where soft steel pole pieces direct the flux path, the shape of the magnet is only one consideration. Since permeance is a measure of the ease with which the flux can get from one pole to the other, it follows that permeance may be increased by providing an easier flux path. Since not all magnets are used in the open circuit condition, it is important to consider the permeance of the complete magnetic circuit.

Figure 18 shows a typical meter magnet, as well as the complete magnetic circuit of a meter movement. The permeance of the magnet alone is represented by the operating line OX , while OY represents the total permeance of the circuit. If no air gap were present, the permeance would increase, and the magnet would operate at Br .

The leakage permeance is determined by the shape of the magnet, and the total permeance will be determined by the magnet and the pole pieces. The difference represents the useful or gap permeance.

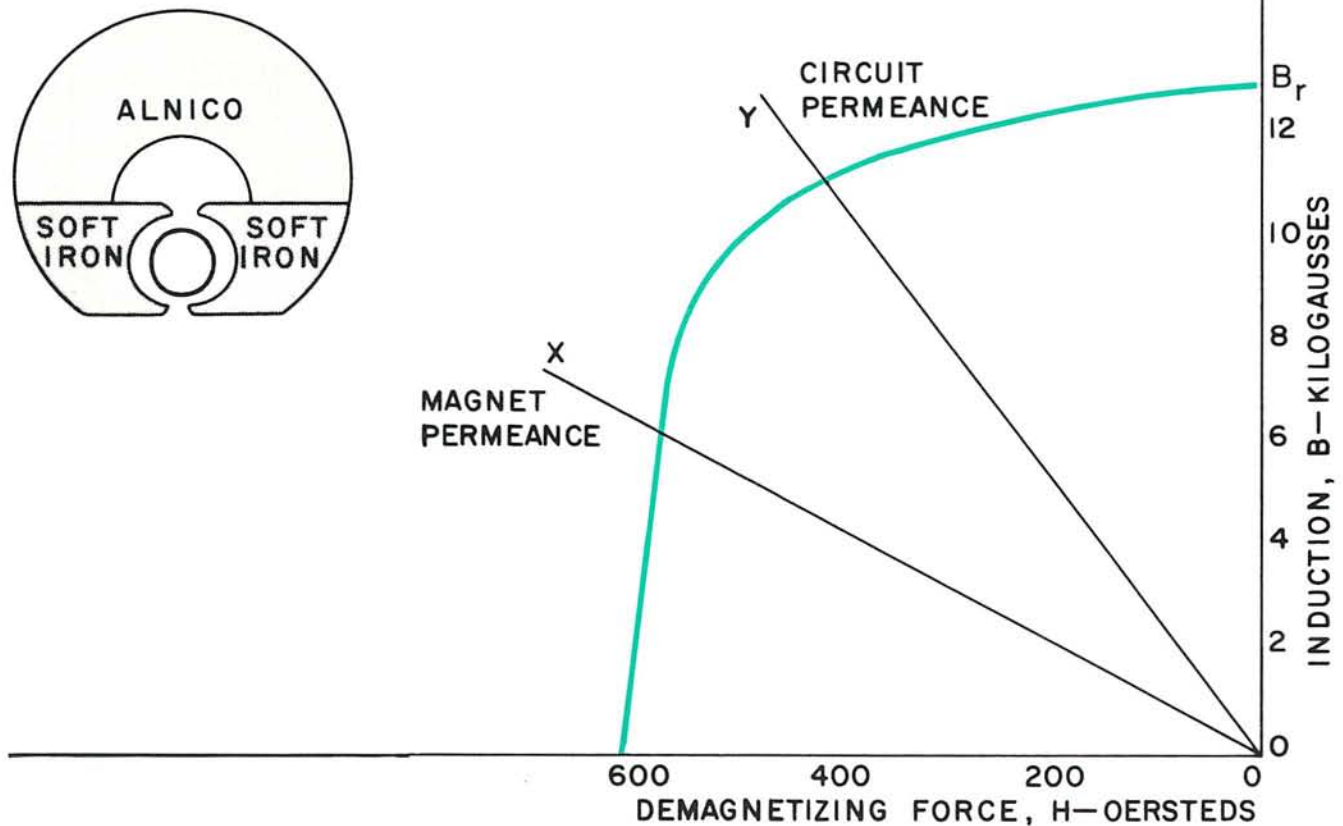

Fig. 18. Permeance data for typical meter magnet. OX represents limb permeance of the magnet alone, while OY represents the total permeance of the circuit.

Variable air gap

In many applications, the operating point of the magnet changes continuously, and the magnet produces different amounts of flux. This may be caused by changing the size of the air gap, as in holding assemblies or magnetic latches, or by the application of an external demagnetizing influence, as in motors or generators. In either case, the effect is the same—changing the permeance of the magnetic circuit—and it is necessary to design for these fluctuations.

Assume that the permeance of the keepered magnet shown in Figure 19 is such that the operating load line is OA . When the keeper is removed, the operating load line drops to OB , or the minimum permeance condition.

If the keeper is now replaced, the permeance increases back to OA . However, instead of retracing the original demagnetization curve, the operating point will recoil along a minor hysteresis loop to point A' . After several cycles of removing and replacing the keeper, this minor loop will be stabilized and may be considered a straight line. The slope of this minor loop, called the **recoil permeability**, is an intrinsic property of the magnetic material, and is one of the most important factors to be considered in designing variable-gap applications. The extremes of magnet permeance and the recoil permeability must be considered in designing a magnetic circuit for volumetric efficiency.

In these dynamic applications, a portion of the flux changes from leakage paths to the useful path as conditions change. Consequently, there is a corresponding change in the useful and leakage energies.

The operating conditions to produce the maximum useful energy for a given magnetic material can be seen graphically in Figure 20. The operating point of the keepered magnet is shown by point G (total permeance), while the operating point of the unkeepered magnet is shown by point C (leakage permeance).

The particular minor loop on which the magnet operates will be determined by point C .

For every material there is a specific point on the demagnetization curve where the resultant minor recoil loop will establish maximum useful energy. The criterion is to set the leakage permeance to intersect this point. Generally speaking, the materials with low values of recoil permeability are capable of producing high values of useful energy.

As the keeper is brought near the magnet, the operating point will move up the minor loop until it reaches point K . Assuming that the leakage permeance remains constant, a useful flux DE exists, and the useful magnetomotive force is EF . Thus, the total useful energy is represented by the rectangular area $KDEF$. It can be shown graphically that this area will be a maximum when point K is set to intersect the minor loop half way between C and G . In magnetic applications where energy is converted

from one form to another, it is necessary to control both the leakage and total permeance to develop maximum volumetric efficiency.*

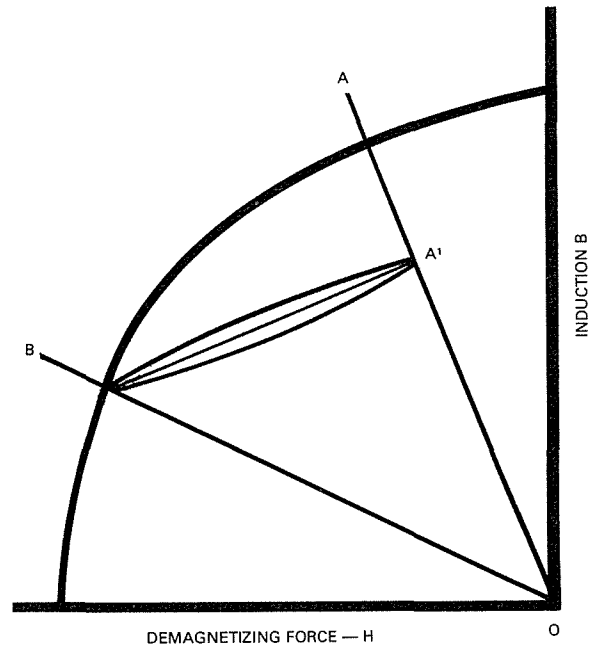

Fig. 19. Demagnetization curve for variable-gap magnet, showing minor hysteresis loop developed by several cycles of removing and replacing the keeper.

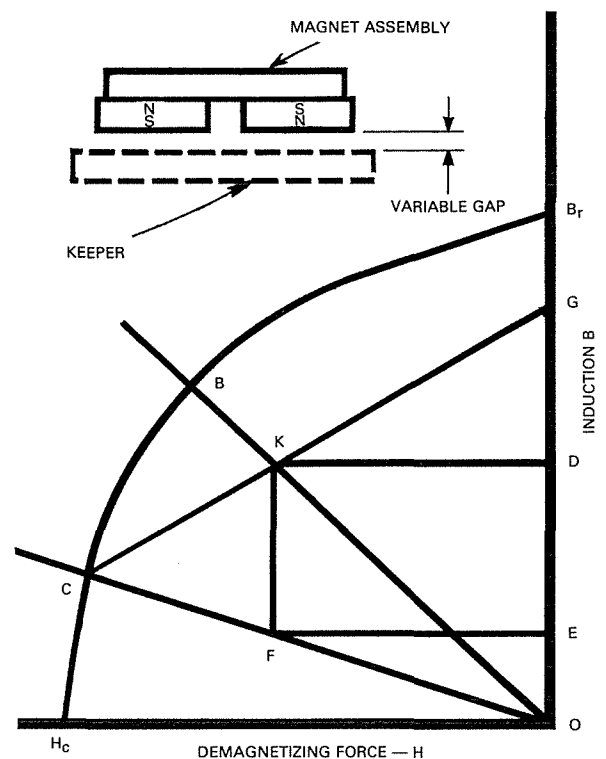

Fig. 20. Operating conditions determine the maximum useful energy (represented by $KDEF$) for a given magnetic material.

*For a complete discussion of magnet design, the reader is referred to "Permanent Magnets and Their Application", John Wiley & Sons, Inc., 1962.

High Permeability Circuit Elements

In permanent magnet circuits, it is often desirable to use high-permeability flux-carrying members to complete a magnetic circuit using only a short length of permanent magnet material as in Fig. 21a; to change the level of flux in a magnetic circuit as in Figure 21b; or to change the direction of flux when working with anisotropy permanent magnet materials as in Figure 21c. The characteristics of some commonly used magnetically soft materials are shown in Figure 22. By far, the most generally used is cold-drawn steel because of its cost and availability. It is desirable to locate the permanent magnet as close to the air gap as possible to minimize flux leakage especially if working the steel near saturation. Figure 23 shows a collection of permanent magnet circuit arrangements in common use, many with high-permeability elements.

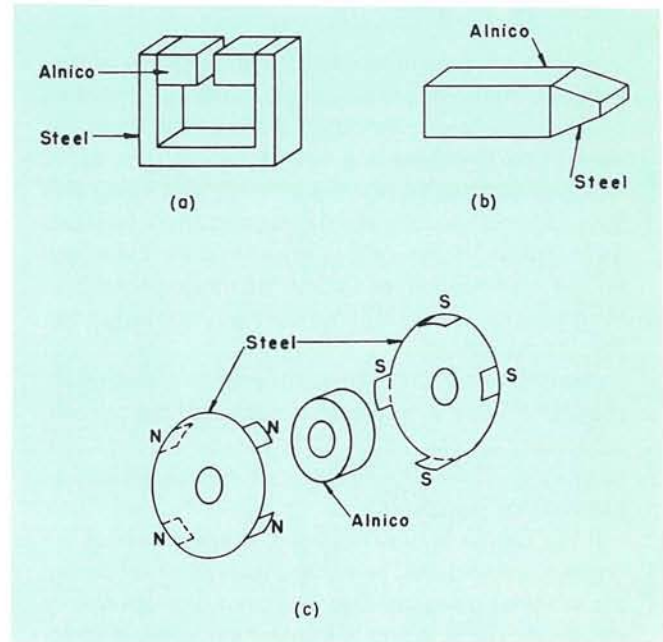

Fig. 21. The use of high permeability steel in permanent magnet circuits.

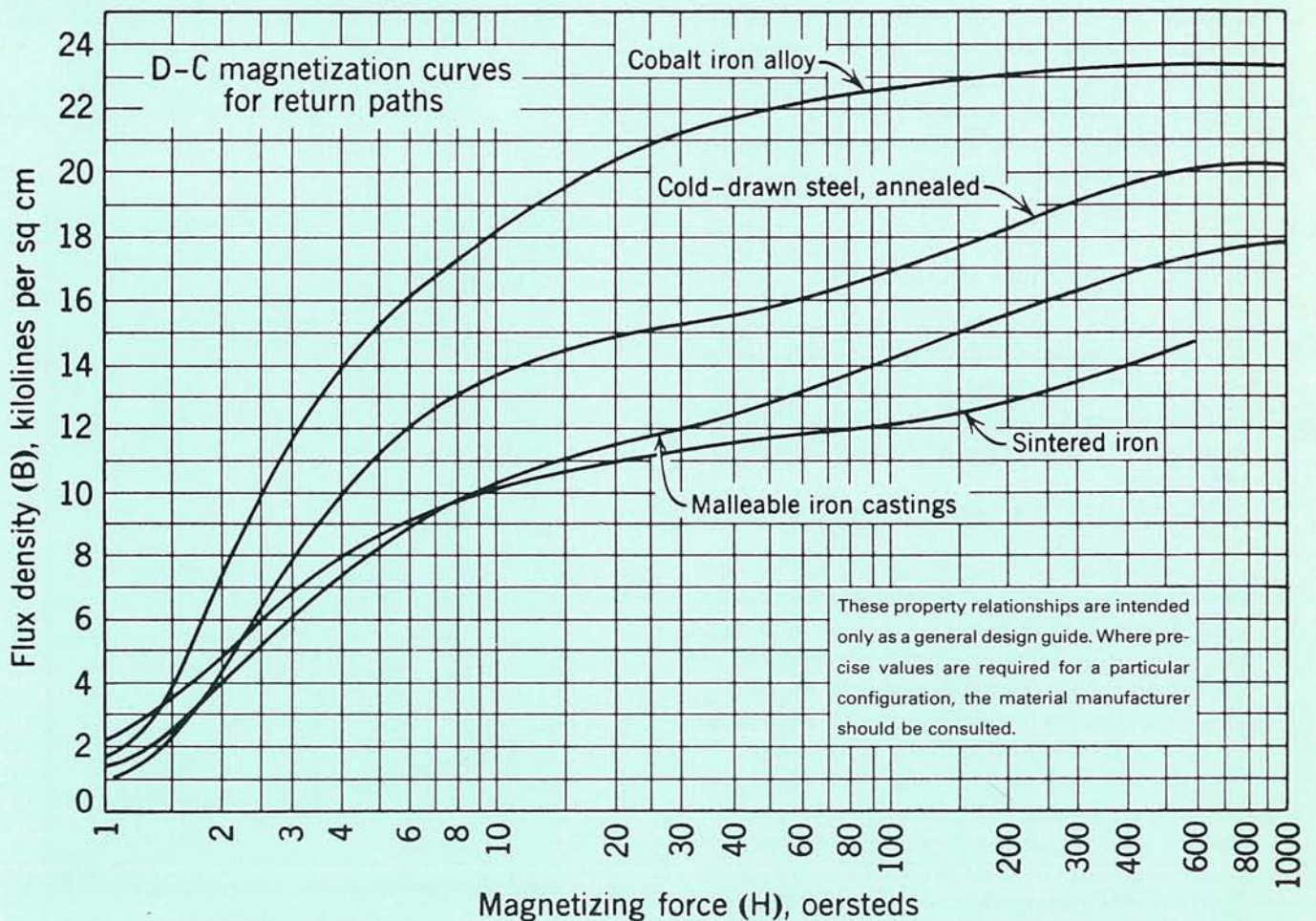

Fig. 22. Magnetization curves for some high permeability materials.

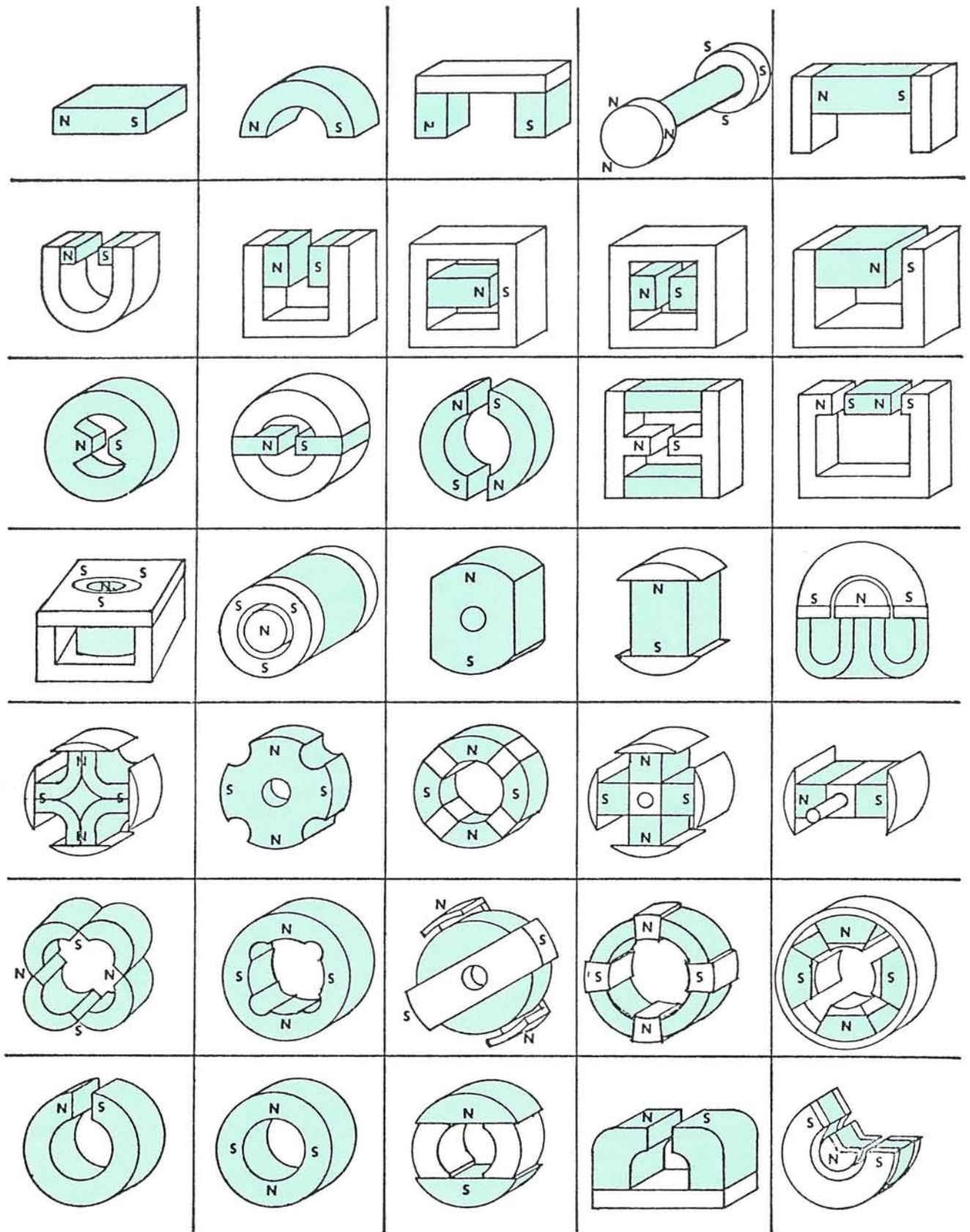

Fig. 23. Typical assemblies used in permanent magnet applications. Shaded portions are permanent magnet material; unshaded portions are high permeability material.

Magnet Stability

In addition to design parameters, physical characteristics and environment must be carefully considered in the application of permanent magnets.

The success of any device which utilizes permanent magnets depends on the ability of the magnet to supply a constant amount of flux to the air gap in any environment to which the device is subjected. Once magnetized, the flux produced by a magnet will remain constant unless external energy is applied to change the balance of the internal energies.

Most applications are subject to influences which do exert external energy on the magnet. Some applications are insensitive to these variations. However, for most applications it is desirable to have a constant supply of flux, or at least to keep the variations to a minimum.

Fortunately, changes in magnetization are fully predictable and may be minimized. The accuracy of precision electrical instruments using permanent magnets over many years of service will attest to the degree of stability that can be achieved by proper design. Assuming that a magnet is prepared by accepted standards, and the external influences to which it will be exposed are fully known, the magnetic flux will not suffer unexplained change.

There are six factors, in addition to the intrinsic magnetic properties of the material, which influence magnet stability:

- a. structural stability
- b. temperature effects
- c. relaxation effects
- d. magnetic field effects
- e. mechanical stress
- f. radiation

Structural stability

Structural instability is due to changes in the crystallographic structure of the material itself, and represents a permanent change in magnetization. In the early martensitic steels, these changes could occur at room temperature, and presented a serious problem to the designer. Today's magnetic materials, however, are insensitive to these variations at room temperature; only elevated temperatures need be considered. Figure 25 lists the temperature ranges at which no structural change has been observed over relatively long periods of time. Also listed are the **Curié temperatures** above which the material is useless as a permanent magnet.

Temperature effects

As the temperature of a ferromagnetic material is raised above absolute zero, the intensity of magnetization will steadily decrease. This is an intrinsic property of the material, and is due to the increased thermal agitation of the elementary electron spin alignment. The individual domain magnetization will therefore vary reversibly with temperature.

Magnetization changes in a permanent magnet, however, are more complex because of the simultaneous and less predictable variations in coercive force with respect to temperature. Generally, coercive force will decrease with increased temperature, but certain materials will exhibit the opposite characteristics in some temperature ranges.

Figure 26 shows the remanent changes which occur with widely-used magnetic materials when they are cooled below room temperature. A coefficient of reversible **remanence** is given, since the variation over these temperature ranges closely approaches a straight line. In Figure 27, similar data is given for losses when magnets are heated above room temperature, showing irreversible loss and stable remanence at the indicated temperature as a percentage of the initial room temperature remanence. Initially, most magnetic materials exhibit some irreversible loss when heated, and then exhibit a reversible remanence decrease with temperature. The **irreversible loss** is attributed to changes in coercive force; the **reversible loss** is due to magnetization changes.

To eliminate irreversible loss in service due to temperature change, it is recommended that the magnet be cycled in the magnetized condition through a temperature range somewhat greater than that expected in service.

If variations with temperature cannot be tolerated, and it is not possible to maintain constant temperature, compensation can be made. The most practical method employs a temperature-sensitive shunt adjacent and parallel to the permanent magnet. At low temperatures the shunt permeability increases, enabling the shunt to carry or direct more flux from the air gap. At higher temperatures, the reverse condition exists; the shunt permeability decreases and less air-gap flux is diverted. For these applications, the most widely-used materials are 30-32% nickel-iron alloys, often referred to as Curié alloys.

Relaxation effects

Relaxation effects are caused by the time required for all parts of the magnet to reach equilibrium condition, in the presence of normal small disturbing influences. An abrupt change in the magnetization of a permanent magnet will, therefore, be followed by a slow approach to equilibrium. These changes are small; for most applications, they can be ignored.

Material	Temperature °C	Curie Temperature ± 10°C
Alnico 1.	450*	780
Alnico 2	450*	815
Alnico 3	450*	760
Alnico 4	450*	800
Alnico 5	550	890
Alnico 6	550	875
Alnico 8	550	860
Remalloy	500	900
Cunico	500*	860
Cunife	400*	450
Vicalloy	500	855
Hicorex	250	700
Barium Ferrite	400*	450

*These Materials, while structurally stable, suffer a considerable remanence loss at these temperatures, especially those with low Curie temperatures.



Fig. 25. Maximum temperature below which no structural change is found.

Material	PERM. COEF. B/H	% Irreversible Loss at Room Temperature After Exposure to		Reversible Temperature Coefficient, % Remanence Change per °C
		-190°C	-60°C	
Alnico 2	25	0	0	-0.025
	16	0	0	-0.021
	9	0	0	-0.018
	6	0	0	-0.009
	3	0	0	-0.014
Alnico 5	50	0	0	-0.022
	25	4.6	1.4	-0.012
	16	9.0	2.5	-0.002
	9	6.2	3.6	+0.010
	6	7.9	3.1	+0.016
Alnico 6	3	8.5	3.4	+0.007
	50	0	0	-0.045
	30	1.8	0.4	-0.020
Alnico 8	16	8.5	1.3	-0.007
	9	10.1	4.1	+0.007
	6	10.5	4.2	+0.022
	3	7.9	3.1	+0.046
	28	0	0	-0.013
Barium Ferrite (Isotropic)	10	0.5	0.1	+0.003
	7	0.7	0.3	+0.015
	3	1.3	0.5	+0.033
	1.5	4.0	0*	-0.19
Barium Ferrite [(BH) max Anisotropic]	0.6	...	1.3	-0.19
	0.3	...	2.4	-0.19
	4.0	...	0*	-0.19
Barium Ferrite [(H _c) max Anisotropic]	1.5	-0.19
	1.2	...	0*	-0.19
Hicorex 90 A & B	10	0	0	-.045
	2	0	0	-.045
	1	0	0	-.045
	0.5	0	0	-.045

Fig. 26. Magnetization changes on cooling below room temperature (20°C).



† In the case of the low temperature irreversible loss occurring in oriented barium ferrite, only the smallest dimension ratio resulting in no irreversible loss at -60°C is shown. This is the recommendation of a major producer, to avoid catastrophic loss. The minimum dimension ratio will depend upon the lowest temperature to be encountered.

Fig. 27. Magnetization losses on heating above room temperature (20°C).



Material	PERM. COEF. B/H	Temperature, °C									
		100		200		300		400		500	
		I	II	I	II	I	II	I	II	I	II
Alnico 2	50	2.0	98	3.1	94	4.2	90	6.1	86	8.2	80
	16	3.1	98	4.0	92	6.9	88	8.6	84	12.0	78
	6	3.5	97	4.7	91	7.4	89	10.7	85	13.1	81
Alnico 5	50	0.1	99.9	0.2	96	0.4	93.6	0.7	91.2	1.2	88.0
	20	0.4	99.6	0.8	96.3	1.1	93.8	1.7	91.1	2.0	88.2
	7	0.5	99.4	1.7	96.6	2.1	94.1	2.6	92.2	3.0	88.6
Alnico 6	150	0.1	98.2	0.2	95.6	0.4	93.0	0.8	89.7	1.8	86.5
	18	0.5	98.7	0.9	95.6	1.2	92.7	2.0	89.4	3.0	85.2
	7	0.7	99.1	1.2	97.2	1.5	94.2	2.1	90.5	3.3	86.0
Alnico 8	28	0.7	98.8								
	9	0.7	99.0								
	7	0.9	99.4								
	3	1.0	99.8								
Barium Ferrite (All Grades)	All	0	85	0	68	0	50				
Hicorex 90 A*	0.5	0.1	96.5	0.5	91.2						
	0.4	0.3	96.3	2.0	89.7						
	0.3	0.6	95.9	2.5	89.2						
	0.2	1.0	95.5	3.5	88.2						
		1.8	94.7	5.5	86.2						
		1.0	0.5	95.7	1.7	88.4					
		0.5	1.0	95.2	3.2	86.9					
		0.4	1.1	95.1	5.2	84.9					
		0.3	1.3	94.9	6.6	83.5					
		1.5	94.7	8.5							

Column I: % irreversible remanence loss at room temperature after heating to indicated temperature.
 Column II: % of initial room temperature remanence found stable with magnet at indicated temperature.
 *Note: Hicorex reversible temperature coefficient is nearly constant for all load lines.

External fields

Magnetic field effects are brought about by the presence of an a-c field, a d-c field, or an adjacent permanent magnet. The ability of a magnet to withstand these external fields is directly proportional to the magnet's intrinsic coercive force. As a result, high coercive materials are required where an external demagnetizing influence will be great. To assure stability of operation, a magnet should be subjected to a demagnetizing force slightly greater than it will see in operation.

If the magnitude of the external field is known, its effect on the flux output of the magnet can be calculated from the intrinsic demagnetization curve. Figure 28 shows the intrinsic and normal demagnetization curves for a typical magnetic material. If the magnet operates at point *a* on the normal curve, it can be seen that the **intrinsic induction** is represented by *a'* (satisfying the equation $B_i = B + H$). A line thru *a'* and the origin will represent the effective permeance. The effect of a demagnetizing field ΔH may be found by drawing a line parallel to the effective permeance line through a point representing ΔH on the $-H$ axis. The intersection of this line with the intrinsic curve will locate the new level of intrinsic induction, *b'*. The normal induction at this point is represented by point *b* on the normal curve, and the flux density will have been reduced by an amount ΔB .

If the external field is removed, the magnet will not return to its original position on the demagnetization curve, but will recoil along a minor hysteresis loop (whose slope is the recoil permeability of the material) until it again intersects the original effective permeance line. This path is shown in Figure 29 as *b* to *c*. The net permanent effect of the demagnetizing influence will be a reduction of flux density to ΔB . Further application of an external field with strength no greater than ΔH will have little or no further effect on induction.

Mechanical stress

Mechanical stress or shock has long been known to demagnetize steel bars. Modern high-coercive-force permanent magnets, however, are generally insensitive to these mechanical degradations. Generally, a mechanical stress large enough to demagnetize permanent magnets would have to be so great that it would physically damage the magnet. For practically all applications, mechanical stresses can be ignored as contributing to instability.

Radiation

Radiation effects have caused increasing concern in recent years. Experiments conducted on present commercially-available permanent magnets have shown no harmful effects on magnetic stability when magnets were subjected to moderate levels of radiation.

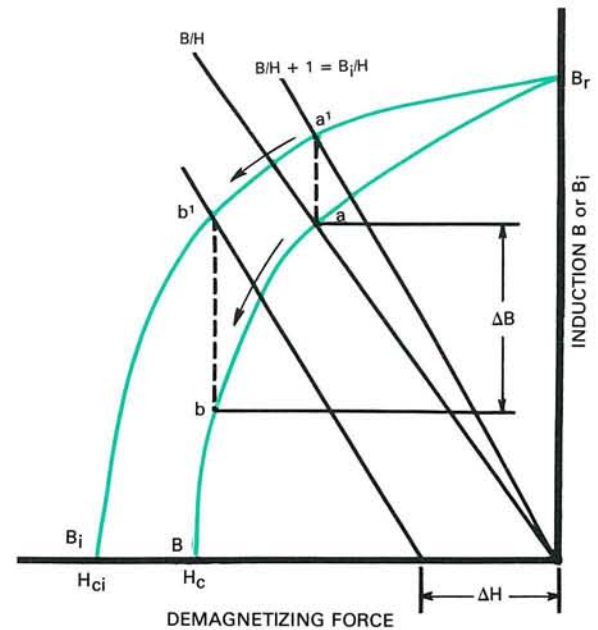

Fig. 28. Intrinsic and normal demagnetization curves for a typical magnet material, showing the effects of a demagnetizing field.

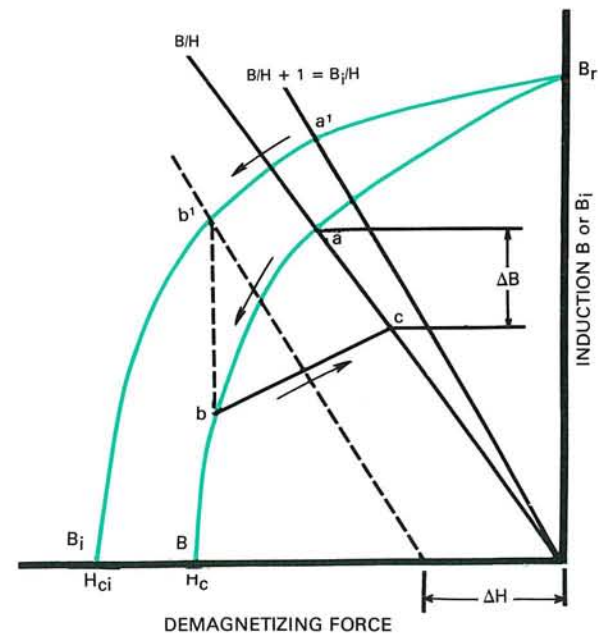

Fig. 29. When the external field is removed, the permanent magnet will recoil along a minor hysteresis loop, and flux density will be reduced by an amount ΔB .

Permanent Magnet Measurements

In development of properties, in design analysis, and in quality control of a particular permanent magnet, component-measurements are vital.

The accurate measurement of magnetic properties is a very important part of permanent magnet technology.

Magnetic Flux Measurement Systems

The two most widely used approaches to the measurement of magnetic flux are the induced voltage method and the Hall Effect method. The basic elements of the induced voltage method are shown in Figure 30. A search coil is inserted in a magnetic field so as to thread the lines of flux. When the coil is withdrawn, a voltage is generated. This voltage, when applied to an indicating instrument having a long natural period of vibration, gives a deflection proportional to the product of coil turns and flux lines threading the coil. Since the turns and coil area can be determined accurately, the deflection can be made proportional to total flux or to the average of the flux density over the coil area. The most commonly used indicating instruments are flux meters, ballistic galvanometers and electronic integrating display devices.

The basic elements in the Hall Effect approach are shown in Figure 31. A thin plate of material such as indium arsenide is placed in a magnetic field with its plane perpendicular to the field. A longitudinal controlled current through the material produces a transverse voltage. This voltage is proportional to the field intensity and hence indicates flux density directly on a d.c. instrument.

Types of Measurements

The type of measurement or test which a particular permanent magnet is given depends on how the magnet is used in actual service and on the magnetic circuit load conditions involved. Many magnets may be tested by a simple open circuit measurement of flux. In cases where the magnet's operating load line is heavily determined by other magnet circuit elements, it is necessary to develop test conditions that simulate the actual load conditions. In some instances, a force measurement is the most meaningful indication of performance. In production testing, in many instances a reference magnet is used to compare quality. Many automated equipments are in use at Hitachi Magnetics Corp. for testing permanent magnets of specific sizes and specifications in large quantities.

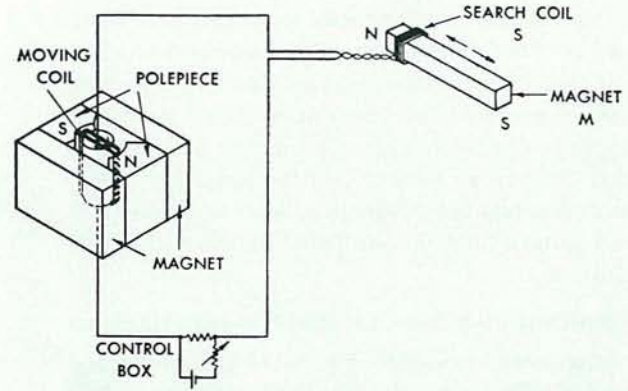

Fig. 30. Basic elements of induction method.

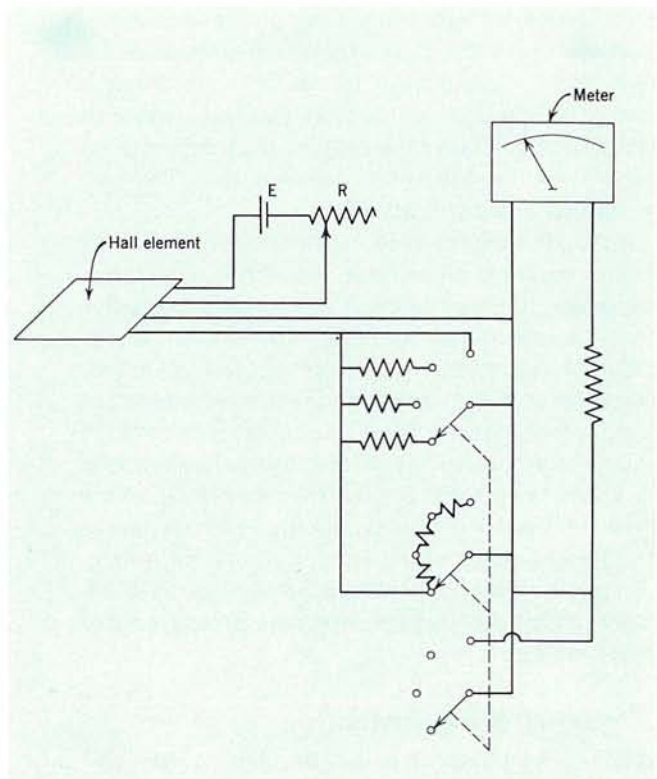

Fig. 31. Schematic diagram of a Hall effect gaussmeter.

Magnetization and Demagnetization

Changing the state of magnetization is an important factor in working with today's high coercive force permanent magnet materials.

Generally the user of the permanent magnet must know how to magnetize, since the magnet manufacturer ships most of the magnets he produces in a demagnetized condition. This is done because the cost of shipping magnetized magnets is high due to the special packaging needed to protect each magnet from the field influence of its neighbors. In addition, demagnetized magnets are easier to assemble into a magnetic circuit, and there is less chance of magnetic dirt being picked up during assembly of such devices as meters and loudspeakers. Thus, most magnets are magnetized after assembly and then given a final "knockdown" for stabilization or calibration.

Requirements for Complete Magnetization

As a general rule of thumb, the field strength (H_s) needed to saturate a magnet is about three to four times the H_{Cj} of the magnet. It has been previously noted that air gaps can create substantial self-demagnetizing effects and, hence, in magnetizing many magnet assemblies, ten to 20 times the H_{Cj} is required.

In addition to using the correct magnitude of field, the field must also be of the correct shape. By arranging current carrying conductors and high permeability pole pieces in various configurations, a great variety of field shapes can be achieved. Subjecting a magnet to field strengths in excess of that required for saturation is not objectionable. It should be noted that fields of an incorrect shape and orientation will leave the magnet magnetized at an angle with respect to the required axis. The end result is partial magnetization.

Although magnetization is theoretically achieved in an extremely short time, the circuit inductance and eddy currents induced in the magnet can influence the rate of magnetization, and can be a major cause of incomplete magnetization. In high induction solenoids and electromagnets, the current may require time in the order of several seconds to reach steady-state values. In addition, the fields produced by the eddy currents oppose the penetration of the field. If the pulse is of short duration with respect to the time constant of the eddy currents, more than one pulse, or longer pulses, may be required. Such is the case with metallic magnets of appreciable cross section.

Magnetizing Equipment

Magnetizing equipment can be divided into two types: steady-state equipment and impulse equipment. Steady-state fields from permanent magnets are occasionally used to magnetize other permanent magnets. Many small permanent magnets are magnetized by insertion into the air gap of a large

permanent magnet. Considerable force is required to remove the magnet, and distortion of the field shape can be a serious problem with this approach. Consequently, permanent magnets are only used as magnetizers on very small magnets where uniformity and distortion are not important.

Usually, steady fields for magnetization are produced by electromagnets with a variable air gap. A typical electromagnet is shown in Figure 32. The principle considerations involved in designing this type of magnetizer are: (1) the core cross section must be adequate to carry saturation induction level for the largest permanent magnet to be magnetized; and (2) the ampere turns must be sufficient to produce the total field required by the magnet to be magnetized, and by the yoke and air gaps that might be present. The electromagnet has leakage energy associated with it, and for this reason, the core of the electromagnet is usually several times as large as the magnet to be saturated. Electromagnets can be arranged with any number of poles. Permanent magnet rotors having many poles may be magnetized in a matching electromagnetic structure. In such an example, all poles must be magnetized simultaneously to ensure a uniform magnet.

In the case of impulse equipment, magnetization can be achieved by a current pulse, provided its magnitude is sufficient to deliver the peak field required. The development of permanent magnet materials with high coercivity and high energy products has led to the need for high output magnetizers. Many of the present-day permanent magnet configurations cannot be fully magnetized by placing them in contact with conventional electromagnets. Instead, they are magnetized by the field set up around conductors carrying short duration currents of great magnitude. Often it is necessary to wrap the limbs of a permanent magnet with a few turns of heavy wire which carry the high current pulse. It should be noted that it is very easy to design a magnet that cannot be fully magnetized; thus the magnetization must be considered during the early stages of design. Impulse magnetization is used in a growing number of situations because of its low cost and ability to operate directly from the alternating current supply lines. The basic elements of an impulse supply are shown in Figure 33. A condenser (C) is charged to a voltage (V), at a rate determined by resistor (R). The condenser is then discharged through the coil or magnetization fixture (L). If R_2 is greater than LC , the resulting pulse will be unidirectional without oscillation. The field developed around a single conductor can be estimated as:

$$H = I/5r$$

where I = peak current in amperes, H = field strength in oersteds and r = maximum radius of the

magnet in centimeters (distance from conductor center to outside of magnet). A properly designed impulse system can develop peak power several hundred times the maximum demand from the line during charging with no need to switch large currents. Discharge times of the order of 0.01 second are common and there is consequently negligible heating of the coil or magnetizing conductor system. Large values of capacitance are economically obtained by paralleling electrolytic capacitors of the type used in photoflash equipment. Figure 34 shows a typical system using an ignitron tube for switching. Figure 35 shows conductor arrangements to magnetize two magnet shapes.

Demagnetization

Demagnetization is not as frequent a problem as magnetization in permanent magnets, but complete demagnetization is extremely difficult to achieve and can be a serious problem for both manufacturer and user of permanent magnets. A permanent magnet may be demagnetized by applying a reverse field of sufficient magnitude to drive it into the third quadrant of the hysteresis loop such that when the field is removed it will recoil to zero induction as shown in Figure 36. By definition, the field that accomplishes this is called the remanent or **relaxation coercive force** (H_{Cr}). To completely demagnetize by

this approach requires accurate knowledge of H_{Cr} and the slope μ_r . For this reason, demagnetization by applying precise amount of reverse field is seldom used. Permanent magnets are generally demagnetized by applying an alternating magnetic field and slowly reducing its magnitude to zero. Figure 36 (a) shows the resulting hysteresis loops as the alternating field and induction approach zero. It is possible to slowly remove the magnet from a fixed magnitude alternating field and achieve the same result. The rate of decay is a very significant factor. Figure 36 (b) shows the results of reducing the peak potential too rapidly. The symmetry of the interior loops is destroyed and the magnet will retain an appreciable level of induction. This method is successful if the initial magnitude of peak field is of the same order of magnitude as required for saturation and if the rate of decay per cycle is small.

Calibration

Permanent magnets in many devices require precise adjustment. Saturated magnets are given a "knockdown" to a given level of B to ensure stability and also to allow for variations in properties arising from production and assembly tolerances. Magnetization equipment are often integrated together to provide precise calibration of permanent magnets.

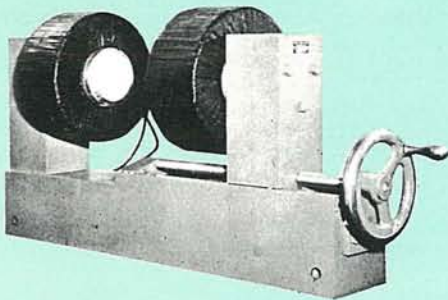

Fig. 32

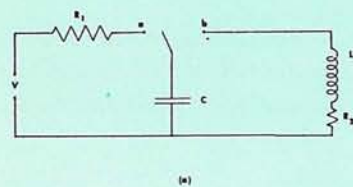

Fig. 33

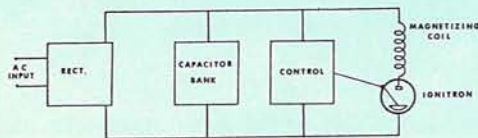

Fig. 34

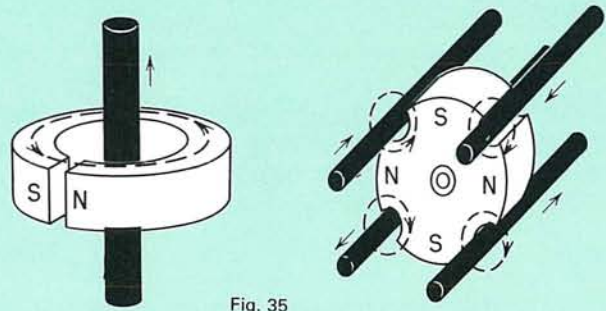

Fig. 35

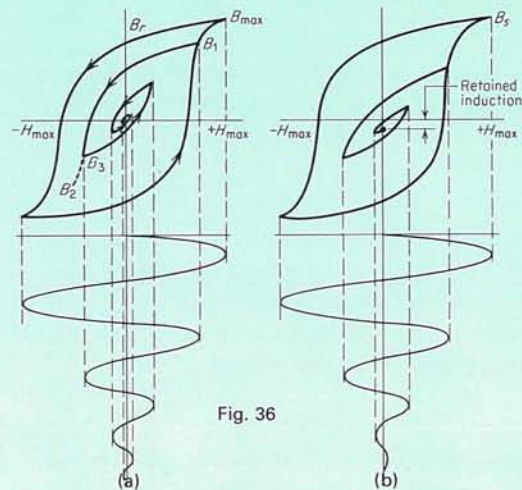

Fig. 36

Fig. 36 (a) Exposing a magnet to a gradually reduced alternating flux field, initially of magnitude H_{max} , will remove any external traces of magnetic induction. (b) If the amplitude of the alternating field is reduced too quickly, the symmetry of the hysteresis loop about the origin may be destroyed and the magnet will retain some induction.

Glossary of Magnet Terms

Air Gap A non-magnetic discontinuity in a ferromagnetic circuit. For example, the space between the poles of a magnet, although filled with brass or wood or any other non-magnetic material, is nevertheless called an air gap.

Circuit, Closed Magnetic A circuit where the magnetic flux is conducted continually around a closed path through ferromagnetic materials. For example a steel ring.

Circuit, Open Magnetic When a magnet does not have a closed external ferromagnetic circuit and does not form a complete conducting circuit itself, the magnet is said to be open circuited. For example, a permanent magnet ring interrupted by an air gap.

Coercive Force, H_C The magnetizing force required to bring the induction to zero in a magnetic material which is in a symmetrically cyclically magnetized condition.*

Coercive Force, Intrinsic, H_{Ci} The magnetizing force required to bring to zero the intrinsic induction of a magnetic material which is in a symmetrically cyclically magnetized condition.*

Coercivity That property of a material measured by the maximum value of the coercive force.*

Core Loss (Iron Loss), P_C The power expended in a magnetic material subjected to a varying magnetizing force.*

Cyclically Magnetized Condition A magnetic material is in a cyclically magnetized condition when, under the influence of a magnetizing force which varies cyclically between two specific limits, its successive hysteresis loops are identical.*

Demagnetization Curve That portion of the hysteresis loop which lies between the residual induction point, B_R and the coercive force point, H_C . Points on this curve are designated by the coordinates B_d and H_d .*

Demagnetizing Force, H_d A magnetizing force applied in such a direction as to reduce the remanent induction in a magnetized body. (See Demagnetization Curve.)*

Diamagnetic Material A material having a permeability less than that of a vacuum.*

Dyne The force producing an acceleration of one centimeter per second per second when applied to a one gram mass.

Eddy Current Loss, P_e That portion of the core loss due to currents circulating in the magnetic material as a result of electromotive forces induced by varying induction.*

Electromagnet A magnet, consisting of a solenoid with an iron core, which has a magnetic field existing only during the time of current flow through the coil.

Energy-Product Curve, Magnetic The curve obtained by plotting the product of the coordinates of the demagnetization curve ($B_d H_d$) as abscissas against the induction B_d .*

Note 1.— $(B_d H_d)_{max}$ corresponds to the maximum value of the external energy.

Note 2.— The demagnetization curve is usually plotted to the left of the vertical axis (negative values of H_d) and the energy product curve to the right.

Erg The work done by a force of one dyne whose point of application is moved through one centimeter in the direction of the force.

Ferromagnetic Material A paramagnetic material which exhibits a high degree of magnetizability.

Gauss The c.g.s. unit of magnetic induction. (See Induction, Magnetic.)*

Gilbert The c.g.s. unit of magnetomotive force. (See Magnetomotive Force.)*

Hysteresis, Magnetic The property of a magnetic material by virtue of which the magnetic induction for a given magnetizing force depends upon the previous conditions of magnetization.*

Hysteresis Loop A curve (usually with rectangular coordinates) which shows, for a magnetic material in a cyclically magnetized condition, for each value of the magnetizing force, two values of the magnetic induction, one when the magnetizing force is increasing, the other when it is decreasing.*

Hysteresis Loss, P_h The power expended in a magnetic material, as a result of magnetic hysteresis, when the magnetic induction is cyclic.*

Induction Curve, Normal A curve depicting the relation between normal induction and magnetizing force.*

Induction, Intrinsic (or Ferric Induction), B_i The excess of the induction in a magnetic material over the induction in vacuum, for a given value of the magnetizing force.*

The equation for intrinsic induction is:

$$B_i = B - \mu_0 H$$

Induction, Magnetic (or Magnetic Flux Density), B Flux per unit area through an element of area at right angles to the direction of the flux.*

The c.g.s. unit of induction is called the gauss and is defined by the equation:

$$B = \frac{d\phi}{dA}$$

Induction, Normal, B The limiting induction, either positive or negative, in a magnetic material which is in a symmetrically cyclically magnetized condition.*

Induction, Remanent, B_d See **Remanence**.

Induction, Residual, B_r The magnetic induction corresponding to zero magnetizing force in a magnetic material which is in a symmetrically cyclically magnetized condition.*

Induction, Saturation, B_s The maximum intrinsic induction possible in a material.*

Keeper A magnetic conductor used to complete the magnetic circuit of a permanent magnet to protect it against demagnetizing influences.

Kilogauss = One kilogauss is equal to 1000 gauss.

Leakage, Flux F That portion of the flux which does not pass through the air gap, or useful part of the magnetic circuit.

Linkage, Flux ϕN The product of the number of turns in an electric circuit by the average value of the flux linked with the circuit.*

Load Line Graphic representation of permeance.

Magnetic Field Strength, H See **Magnetizing Force**.

Magnetic Flux, ϕ A condition in a medium produced by a magnetomotive force, such that when altered in magnitude a voltage is induced in an electric circuit linked with the flux.*

The c.g.s. unit of magnetic flux is called the maxwell and is defined by the equation:

$$e = -N \frac{d\phi}{dt} 10^{-8}$$

where:

e = induced emf. in volts, and

$\frac{d\phi}{dt}$ = time rate of change of flux in maxwell per second.

Flux Density, B See **Induction Magnetic**.

Magnetic Line of Force An imaginary line in a magnetic field which at every point has the direction of the magnetic flux at that point.*

Magnetizing Force, H Magnetomotive force per unit length. The c.g.s. unit is called the oersted and is defined by the equation:

$$H = \frac{d\mathcal{F}}{dl}$$

where l is in amperes and L is in centimeters.*

where \mathcal{F} is in gilberts and L in centimeters. For a toroid, or at the center of a long solenoid, the magnetizing force in oersteds may be calculated as follows:

$$H = \frac{0.4\pi NI}{L}$$

Magnetomotive Force, \mathcal{F} That which tends to produce a magnetic field. In magnetic testing it is most commonly produced by a current flowing through a coil of wire, and its magnitude is proportional to the current, and to the number of turns.*

The c.g.s. unit of magnetomotive force is called the gilbert and is defined by the equation:

$$\mathcal{F} = 0.4\pi NI$$

where I is in amperes.

Magnetomotive force may also result from a magnetized body.

The c.g.s. unit of magnetic flux.*

Note:—1 maxwell equals 10^{-8} webers.

Oersted, H The c.g.s. unit of magnetizing force.*

Paramagnetic Material A material having a permeability which is slightly greater than that of a vacuum, and which is approximately independent of the magnetizing force.*

Permanent Magnet Material Shaped piece of ferromagnetic material which once having been magnetized, shows definite resistance to external demagnetizing forces, i.e., requires a high coercive force to remove the resultant magnetism.

Permeability, Differential, μ_d The slope of the normal induction curve.*

Permeability, Incremental, μ_Δ The ratio of the cyclic change in magnetic induction to the corresponding cyclic change in magnetizing force when the mean induction differs from zero.*

Permeability, Initial, μ_0 The slope of the normal induction curve at zero magnetizing force.*

Permeability, Intrinsic, μ_i The ratio of intrinsic normal induction to the corresponding magnetizing force.*

Permeability, Normal, μ The ratio of the normal induction to the corresponding magnetizing force.*

In the c.g.s. system the flux density in a vacuum is numerically equal to the magnetizing force and, consequently, the magnetic permeability is numerically equal to the ratio of the flux density to the magnetizing force. Thus:

$$\mu = \frac{B}{H}$$

Note.—In a nonisotropic medium the permeability is a function of the orientation of the medium, since, in general, the magnetizing force and the magnetic flux are not parallel.

Permeability, Relative, μ_r Permeability of a body relative to that of a vacuum. In the c.g.s. system the relative permeability is the same as the normal permeability.*

Permeability, Space, μ_v The factor that expresses the ratio of magnetic induction to magnetizing force in a vacuum. In the c.g.s. electromagnetic system of units the permeability of a vacuum arbitrarily taken as unity.*

Permeance, P The ratio of the flux through any cross section of a tubular portion of a magnetic circuit bounded by lines of force and by two equipotential surfaces to the magnetic potential difference between the surfaces, taken within the portion under consideration.*

Poles, Consequent Additional magnetic poles which are present at other than the ends of a magnetic material.

Poles, North and South Magnetic The north pole of a magnet, or compass, is attracted toward the north magnetic pole of the earth, and the south pole of a magnet is attracted toward the south magnetic pole of the earth. This is based upon tradition and not physics, as, actually, two unlike poles will attract each other while like poles repel. However, the north seeking pole of a magnet is designated by the letter N , and the other pole by S . The N pole of one magnet will attract the S pole of another magnet.

Reluctance, \mathcal{R} The reciprocal of permeance

$$\mathcal{R} = \frac{\mathcal{F}}{\phi}$$

For uniform μ and A

$$\mathcal{R} = \frac{L}{\mu A}$$

where A is area in square centimeters and L is length in centimeters.*

Remanence (or Remanent Induction), B_d The magnetic induction which remains in a magnetic circuit after the removal of an applied magnetomotive force.*

Note.— If there is an air gap in the magnetic circuit, the remanence will be less than the residual induction.

Retentivity The property of a magnetic material measured by the maximum value of the residual induction.*

Soft Magnetic Material Shaped piece of ferromagnetic material which once having been magnetized is very easily demagnetized, i.e., requires a slight coercive force to remove the resultant magnetism.

Stabilization A treatment of a magnetic material designed to increase the permanency of its magnetic properties or condition.*

Symmetrically Cyclically Magnetized Condition A magnetized material is in a symmetrically cyclically magnetized condition when it is cyclically magnetized and the limits of the applied magnetizing forces are equal and of opposite sign, so that the limits of induction are equal and of opposite sign.*

Weber The practical unit of magnetic flux. It is the amount of magnetic flux which, when linked at a uniform rate with a single-turn electric circuit during an interval of 1 sec., will induce in this circuit an electromotive force of 1 volt.*

$$1 \text{ weber} = 10^8 \text{ maxwells.}$$

*Definitions from A.S.T.M. Designation A 340-64, "Standard Definitions of Terms with Symbols, Relating to Magnetic Testing," 1964.

SYMBOLS

A = Cross sectional area of magnetic material.	B_s = Saturation induction.	P = Permeance.
A_g = Cross sectional area of the air gap perpendicular to the lines of flux.	F = Flux leakage.	P_c = Core loss.
A_m = Cross sectional area of magnet perpendicular to direction of magnetization.	F = Magnetomotive force.	P_e = Eddy current loss.
Magnetic induction.	F = Magnetic potential difference.	P_h = Hysteresis loss.
B = Normal induction.	Magnetizing force.	R = Reluctance.
Magnetic flux density.	H = Magnetic intensity.	Permeability
B_d = Remanent induction; values of magnetic induction on the demagnetization curve.	H_c = Coercive force.	μ = Normal permeability.
B_g = Magnetic flux density in the air gap.	H_{ci} = Intrinsic coercive force.	μ_d = Differential permeability.
B_i = Intrinsic induction.	H_d = Demagnetizing force; values of demagnetizing force on the demagnetization curve.	μ_i = Intrinsic permeability.
B_r = Residual induction.	H_g = Magnetizing force in the air gap.	μ_0 = Initial permeability.
	L = Length of magnetic circuit element.	μ_r = Reversible permeability.
	N = Total number of turns.	μ_v = Space permeability.
		$\mu\Delta$ = Incremental permeability,
		ϕ = Magnetic flux.
		ϕN = Flux linkage.

Reference to the Technical Literature

1. Permanent Magnets, F. G. Spreadbury, Pitman & Sons, Ltd., London 1949.
2. Permanent Magnets and Their Application, R. J. Parker & R. J. Studders, J. Wiley & Sons, NY 1962.
3. Permanent Magnets & Magnetism, D. Hadfield, J. Wiley & Sons, NY 1962.
4. High Temperature Stability of Permanent Magnets of the Iron-Nickel-Aluminum System, A. G. Clegg and M. McCraig, British J. Appl. Phys., 144 1958.
5. Ferrites, J. Smit and H. Wijn, J. Wiley & Sons, NY, 1959.
6. Cobalt-Rare Earth Permanent Magnet Alloys, D. L. Martin and M. G. Benz, Cobalt, 50, 11 (Mar 1971).
7. The Properties and Potential Uses of Rare Earth Permanent Magnets, R. J. Parker, Intermag Conference Workshop, Denver, Co., 1971.

Units

Throughout this manual C.G.S. units have been used. Today most permanent magnet problems are solved using C.G.S. units. However, there is a strong trend to use the S.I. or MKSA System of units in scientific and technical education. In order to convert between the two systems of units, this Table is presented for reference.

QUANTITIES, SYMBOLS, UNITS, AND CONVERSION FACTORS

Quantity	Unit, C.G.S.	Unit, S.I.	(S.I.)/(C.G.S.) Ratio*
Length, L	Centimeter, cm	meter, m	10^2
Mass, M	gram, g	kilogram, kg	10^3
Time, t	second, s	second, s	1
Electric current, I	abampere	ampere, A	10^{-1}
Temperature, T	degree celsius °C	kelvin, K	$(K = °C + 273.16)$
Force, F	dyne	newton, N	10^5
Work or energy, E	erg = dyn.cm	joule, J = Nm	10^7
Power, P	erg/s	watt, W = J/s	10^7
Magnetic flux ϕ	maxwell	weber, Wb	10^8
Flux density, B	gauss, G	tesla, T = Wb/m ²	10^4
Magnetic constant, μ_0 (permeability of space)	(unity)	henry/meter, H/m	$10^7/4 \pi$
Intensity of magnetization, J	e.m.u. = G/4 π = dyn/cm ² Oe	tesla, T = N/Am	$10^4/4 \pi$
Magnetic field strength, H	oersted, Oe	ampere/meter, A/m	$4 \pi/10^3$
Magnetomotive force, F	gilbert, Gb	ampere, A	$4 \pi/10$
Reluctance, \mathcal{R}_m	gilbert/maxwell	l/henry, H ⁻¹	$4 \pi/10^9$
Permeance (inverse of reluctance) P	maxwell/gilbert	henry, H	$10^9/4 \pi$

* A quantity in S.I. units must be multiplied by this ratio to convert it to C.G.S. units.

Specifying the Permanent Magnet

The permanent magnet is by and large a specialty component and must be carefully integrated into a magnetic circuit environment. For best results, a drawing must be supplied giving all dimensions, tolerance surface conditions, type of material, direction of magnetization, and some information about the type of magnetic circuit involved. The quantity and delivery requirements are needed since they influence the tooling, time required for tooling, and cost.

The following considerations should be carefully reviewed in order to arrive at a drawing which describes the conditions to be met.

Choice of Material

There are many materials available, but not all are suitable for various shapes and sizes of production magnets. In many instances HMC can make recommendations if sufficient information is given about the design.

Grinding

Most permanent magnet materials require grinding to achieve close tolerances. Ground surfaces can add appreciable cost, and one should carefully study the need. In many instances, "as cast" or "as sintered" tolerances can be used, with a saving in cost.

Surface Conditions

Many magnets that require close tolerances and a grind do not need high quality surface conditions. Generally the surface conditions are not critical to the performance of the magnetic circuit. Before one adds a surface mark to a drawing, it should be considered carefully because of the cost of producing and inspecting high finish surfaces.

Direction of Magnetization

Specification of the direction of magnetization is needed in all anisotropic materials and should be noted on drawing with an arrow and the letter M:

← M →

State of Magnetization

It is necessary to specify the state of magnetization. Although most permanent magnets are shipped unmagnetized, the new high coercive force materials make it possible to magnetize before assembly and hence, in a growing number of instances, customers are specifying magnetized magnets.

Testing Permanent Magnets

The unit property curves are typical of property achievement on easily measured test bars, and they are intended only as a design guide. When acceptance test levels are appropriate on a specific magnet, the user and producer must exchange information and arrive at a mutually acceptable test method and level. In establishing test levels, it is well to bear in mind the tolerances involved, and to carefully consider cost, by having an acceptance level placed in the manufacturing quality distribution curve so that a high yield is possible.

Typical Magnetic and Physical Properties of Hitachi Metals America Permanent Magnets

MATERIAL	Recommended Magnetizing Force H_s (Oersteds)	Residual Induction B_r (Gausses)	Coercive Force H_c (Oersteds)	Intrinsic Coercive Force H_{ci} (Oersteds)	Peak Energy Product ($B_d H_d$) Max. (MGO)	Peak Energy Product Occurs at B_d	Peak Energy Product Occurs at H_d	Permeance Coefficient ($B_d H_d$)	Average Recoil Permeability	Density (Pounds per cu. in.)	Tensile Strength (p.s.i.)	Transverse Modulus of Rupture. (p.s.i.)	Hardness (Rockwell "C")	Coefficient of Thermal Expansion per °C x 10 ⁶	Resistivity (Micro-ohms per cm/cm ²) @ 25°C	MMPA Equivalent
CAST ALNICO																
2	2,500	7,200	540	-	1.60	4,500	365	12.0	6.4	0.256	3,000	7,200	45	12.4	65	
3	2,500	6,700	450	-	1.40	4,300	320	13.0	6.5	0.249	12,000	22,500	45	13.0	60	
4	3,500	5,200	700	-	1.20	3,000	380	8.0	4.1	0.253	9,100	24,000	45	13.1	75	
5	3,000	12,400	640	-	5.50	10,000	550	18.0	4.3	0.264	5,450	10,500	50	11.6	47	
5DG	3,500	12,600	670	-	6.25	10,450	600	17.0	4.0	0.264	5,200	9,000	50	11.4	47	
5-7	3,500	13,000	730	-	7.25	11,150	650	17.0	3.8	0.264	5,000	8,000	50	11.4	47	
6	4,000	10,200	770	-	3.75	7,000	535	13.0	5.3	0.268	23,000	45,000	50	11.4	50	
ISO.8	5,000	5,800	1,300	-	2.20	3,400	650	5.2	1.9	0.262	39,500	30,000	56	11.0	50	
8A	8,000	8,500	1,600	-	5.20	5,200	1,000	5.0	2.0	0.262	39,500	30,000	56	11.0	50	
8B	8,000	7,800	1,850	-	5.20	4,500	1,150	3.9	1.9	0.262	39,500	30,000	56	11.0	50	
8C	8,000	9,000	1,480	-	5.20	5,800	900	6.4	2.1	0.262	39,500	30,000	56	11.0	50	
SINTERED ALNICO																
2	2,500	6,800	520	-	1.50	4,300	350	12.3	6.4	0.247	65,000	70,000	43	12.4	68	
ISO.8	5,000	5,800	1,200	-	2.10	3,000	700	4.3	1.9	0.252	50,000	55,000	43	11.6	53	
5	3,000	10,500	590	-	3.50	8,000	435	18.4	4.0	0.253	50,000	55,000	44	11.3	50	
6	4,000	8,600	790	-	3.00	6,000	500	12.0	4.5	0.249	55,000	100,000	44	11.3	53	
8A	8,000	7,600	1,550	-	4.50	4,700	960	5.0	2.1	0.252	50,000	55,000	43	11.6	53	
8B	8,000	6,500	1,800	-	4.50	4,100	1,100	3.7	1.9	0.252	50,000	55,000	43	11.6	53	
CERAMIC																
YMB-1BB	7,000	3,950	2,400	-	3.70	-	-	-	-	.187	-	-	-	-	>10*	Ceramic 5
YBM-2D	12,000	3,500	2,950	3,250	2.85	-	-	-	-	.178	-	-	-	-	>10*	Ceramic 6
YBM-2CS	10,000	3,850	2,750	2,850	3.45	-	-	-	-	.182	-	-	-	-	>10*	
YBM-2B	13,000	3,950	3,100	3,200	3.70	-	-	-	-	.182	-	-	-	-	>10*	Ceramic 8
YBM-2BA	10,000	4,275	2,400	-	4.35	-	-	-	-	.184	-	-	-	-	>10*	
YBM-2BB	12,000	4,225	2,950	-	4.20	-	-	-	-	.184	-	-	-	-	>10*	
YBM-2BC	15,000	3,600	3,200	4,000	3.05	-	-	-	-	.178	-	-	-	-	>10*	Ceramic 7
YBM-2BD	15,000	3,850	3,100	3,650	3.50	-	-	-	-	.182	-	-	-	-	>10*	
YBM-7BE	15,000	3,800	3,300	3,900	3.40	-	-	-	-	.178	-	-	-	-	>10*	
YBM-3	12,000	2,150	1,800	3,600	1.00	-	-	-	-	.180	-	-	-	-	>10*	Ceramic 1
Radial Oriented																
YBM-4A	-	over 2,500	over 2,000	over 3,000	over 1.4	-	-	-	-	-	-	-	-	-	-	-
YBM-4B	-	over 2,700	over 2,300	over 3,000	over 1.7	-	-	-	-	-	-	-	-	-	-	-
HICOREX																
90A	35,000*	8,200	7,500	>30,000	16	4,000	4,000	1.0	1.05	.295	5,000	-	-	-	50	
90B	20,000*	8,700	8,200	>15,000	18	4,250	4,250	1.0	1.05	.298	5,000	-	-	-	50	
96A	20,000	9,000	8,300	15,000	19.5	4,400	4,400	1.0	1.05	.298	5,000	-	-	-	50	
96B	15,000	9,400	8,800	15,000	21.5	4,560	4,560	1.0	1.05	.298	5,000	-	-	-	50	
99A	15,000	9,700	6,000	6,500	21.5	-	-	1.3	-	.300	-	-	55	-	50	
99B	15,000	10,000	6,000	6,500	24.0	-	-	1.2	-	.300	-	-	55	-	50	
99C	15,000	10,600	6,000	6,500	27.0	-	-	1.15	-	.300	-	-	55	-	50	
Fe Cr Co																
KHJ-1	3,000	12,900	600	-	5.6	10,500	550	20	2.8	.274	28,300	-	36	11.3	68	
KHJ-2	-	11,500	750	-	4.5	8,200	550	15	4.4	-	-	-	-	-	-	
KHJ-3B	-	13,500	700	-	7.0	11,600	600	20	2.5	-	-	-	-	-	-	

* Recommended magnetizing fields are for closed magnetic circuits and for magnets that have been thermally demagnetized. Higher fields are required if demagnetization state was achieved by a magnetic field.



HITACHI METALS AMERICA, LTD.

Magnetic Materials Division

7800 NEFF ROAD • EDMORE, MICHIGAN 48829 U.S.A.
PHONE (517) 427-5151 • FAX (517) 427-5772 or (517) 427-5571

Sales Offices

Boston Office

Hitachi Metals America, Ltd.
475 Hillside Avenue
Needham, MA 02194 U.S.A.
Tel. 617/444-6533
FAX 617/444-8775

Chicago Office

Hitachi Metals America, Ltd.
2101 S. Arlington Heights Road, Suite 107
Arlington Heights, IL 60005 U.S.A.
Tel. 708/364-7200
FAX 708/364-7279

Los Angeles Office

Hitachi Metals America, Ltd.
5000 E. Spring Street, Suite 360
Long Beach, CA 90815 U.S.A.
Tel. 310/496-2474
FAX 310/496-2672

Boulder Office

Hitachi Metals America, Ltd.
5350 Manhattan Circle, Suite 230
Boulder, CO 80303 U.S.A.
Tel. 303/494-8903
FAX 303/494-3321

Cleveland Office

Hitachi Metals America, Ltd.
Plaza South II, Suite 404
7261 Engle Road
Middleburg Heights, OH 44130 U.S.A.
Tel. 216/243-6993
FAX 216/243-0230

Nashville Office

Hitachi Metals America, Ltd.
3343 Perimeter Hills Drive, Suite 314
Nashville, TN 37211 U.S.A.
Tel. 615/831-2963
FAX 615/831-7108

Charlotte Office

Hitachi Metals America, Ltd.
4601 Charlotte Park Drive, Suite 210
Charlotte, NC 28217 U.S.A.
Tel. 704/525-6796
FAX 704/522-7189

Edmore Office

Hitachi Metals America, Ltd.
7800 Neff Road
Edmore, MI 48829 U.S.A.
Tel. 517/427-5151
FAX 517/427-5772

HITACHI METALS, LTD. MAGNETIC MATERIALS DIVISION

Japan Office

Hitachi Metals, Ltd.
Magnetic Materials Division
Kishimoto Bldg.
2-1 Marunouchi 2 Chome
Chiyoda ku, Tokyo, Japan
Tel. 03(3284)4511
FAX 03(3215)6853

Germany Office

Hitachi Metals Europe GmbH
Immermannstrasse 14-16, 4000
Dusseldorf 1, Germany
Tel. 211/16009-0
FAX 211/16009-29

Singapore Office

Hitachi Metals Singapore Pte. Ltd.
78 Shenton Way #12-01
Singapore 0207
Tel. 222/3077
FAX 222/5232

MANUFACTURING PLANTS

Hitachi Magnetics Corporation

7800 Neff Road
Edmore, MI 48829 U.S.A.
Tel. 517/427-5151
FAX 517/427-5571

Hitachi Metals, Ltd. - Kyushu Works

35 Nagahama Cho Kand Cho Kyoto-Gun
Fukuoka Prefecture, Japan
Tel. 093-436-2700
FAX 093-434-6528

Hitachi Metals North Carolina, Ltd.

1 Hitachi Metals Drive
China Grove, NC 28023 U.S.A.
Tel. 704/855-2800
FAX 704/855-2750

Hitachi Metals, Ltd. - Kumagaya Works

5200 Mikajiri Kumagaya City
Saitama Prefecture, Japan
Tel. 0485-31-1111
FAX 0485-33-1657